

## GC2e Panel Installation and Programming Guide

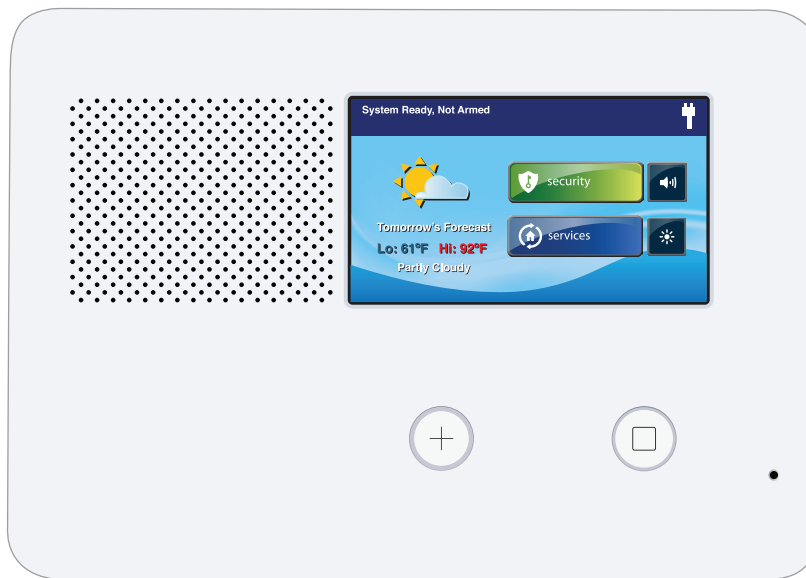

V1.121 Firmware

## WIRELESS SECURITY SYSTEM



# CONTENTS

<b>Introduction</b>	<b>4</b>
About this Guide	4
About the 2GIG Go!Control System	4
Important Information	4
Installing the System in Residential Settings	4
Installing the System in Commercial Settings	5
System Features	5
Optional Accessories	6
<b>System Configuration</b>	<b>7</b>
<b>Control Panel Features</b>	<b>8</b>
External Features	8
Internal Features	9
<b>Installation Outline</b>	<b>10</b>
<b>Wireless Installation Tips</b>	<b>11</b>
<b>Sensors and Accessories</b>	<b>12</b>
Wireless System Sensors	12
System Accessories	12
<b>Installation</b>	<b>13</b>
Control Panel Mounting Plate	13
Wireless Sensors	14
Hardwired Loops	14
Wiring	14
Remote Alarm Sounder	14
LTE (Cellular) Radio Module	15
Control Panel Wiring Diagram	16
Control Panel Wiring	17
Terminal Block Wiring Diagram	17
Backup Battery Connection and Power Supply Wiring	17
Wire Size and Length	17
Control Panel and Power Supply Mounting	18
<b>Commercial Installations</b>	<b>19</b>
<b>NFPA Standard 72</b>	<b>20</b>
<b>Main Display Screens</b>	<b>21</b>
Home Screen	21
Security Screen	21
Arming Screen	21
Menu Screen	21
System Status Screen	22
<b>Toolbox and Installer Toolbox</b>	<b>23</b>
Toolbox Screens	23
Accessing the Toolbox	23
Installer Toolbox Screens	23
Accessing the Installer Toolbox	23
Accessing the System Configuration for System and Sensor Programming	23
System Configuration Screens	24
<b>System Status Icons</b>	<b>25</b>
AC Power On/OFF	25
Sounder Disabled	25
Low Backup Battery	25
Test Mode	25
Touch Screen Keypad Traffic	25
Cell Radio	25
Interior sensor open	25
<b>Programming Navigation</b>	<b>26</b>
Questions without Sub-Options	26
Questions with Sub-Options	26
Questions with Data Entry	26
Additional Buttons	27
<b>Programming Outline</b>	<b>28</b>
ANSI/SIA CP-01 Compliance	28
<b>Programming Question Table</b>	<b>29</b>
<b>Zone Numbering</b>	<b>32</b>
<b>Sensor Types (Zones)</b>	<b>33</b>
Sensor Type (Zone)	34
Description	34
<b>Voice Descriptors</b>	<b>35</b>
<b>Installer Programming</b>	<b>38</b>
Account Registration	38
Wireless (RF) Sensor Programming	38
Q1: RF Sensor Programming Outline	39
Summary of RF Sensor # Screen	39
RF Sensor Programming Questions	39
Wired Sensor Programming	41
Summary of Wired Sensor # Screen	42
Wired Sensor Programming Questions	42
Wireless (RF) Key Fob Programming	44
Key Fob Programming Outline	45
Q3: RF Key Fob Programming Outline	45
Summary of RF Key Fob # Screen	45

RF Key Fob Programming Questions .....	45
Wireless (RF) Keypad Programming .....	46
RF Keypad Programming Outline .....	47
Q4: RF Key Pad Programming Outline .....	47
Summary of RF Keypad Screen .....	47
RF Keypad Programming Questions .....	47
<b>Control Panel Programming .....</b>	<b>49</b>
Programming Questions .....	49
Q1: RF Sensor Programming .....	49
Q2: Wired Sensor Programming .....	49
Q3: RF Key Fob Programming .....	49
Q4: RF Keypad Programming .....	49
Q5: Exit Delay, in Seconds (45-120) .....	49
Q6: Entry Delay 1, in Seconds (30-240) .....	49
Q7: Entry Delay 2, in Seconds (30-240) .....	49
Q13: 2-Way Voice (0-2) .....	49
Q14: Silent Panic/Burglary Listen Only .....	49
Q16: Police Emergency Key (0-2) .....	50
Q17: Fire Emergency Key (0-1) .....	50
Q18: Emergency Key (0-1) .....	50
Q19: Quick Arming (0-1) .....	50
Q20: Swinger Shutdown Count (1-6) .....	50
Q21: Siren Supervision Time (0-3) .....	50
Q22: CS Lack of Usage Notification Time (0-255) .....	50
Q23: Radio Modem Network Failure Time (0-255) .....	50
Q24: Radio Modem Network Failure Causes Trouble (0-1) .....	50
Q25: Radio Modem Network Failure Reports (0-1) .....	51
Q26: Auto Stay (0-1) .....	51
Q27: Exit Delay Restart (0-1) .....	51
Q28: Quick Exit (0-1) .....	51
Q29: Periodic Test, in Days (0-255) .....	51
Q31: Cancel Time, in Minutes (5-255) .....	51
Q32: Cancel Display (0-1) .....	51
Q33: Cross Sensor 47-48 (0-1) .....	51
Q34: Cross Sensor Timeout, in Seconds (10-120) .....	51
Q38: Time to Detect AC Loss, in Minutes (0-30) .....	52
Q35: Abort Window Dialer Delay (0-2) .....	52
Q36: Burglary Bell Cutoff (0 to 4) .....	52
Q37: Fire Bell Cutoff (0-4) .....	52
Q39: Random AC Loss Report Time (0-1) .....	52
Q43: Installer Code (4 Digits) .....	52
Q44: Lock Installer Programming (0-2) .....	52
Q45: Lock Default Programming (0-2) .....	53
Q46: Trouble Doesn't Sound at Night (0-1) .....	53
Q47: Trouble Resound After Hold Off (0-7) .....	53
Q49: Programming Mode Entry Reports to CS (0-1) .....	53
Q50: Trouble Reports to CS (0-1) .....	53
Q51: Manual Bypass Reports to CS (0-1) .....	53
Q52: AC Loss Reports to CS (0-1) .....	53
Q53: System Low Battery Reports to CS (0-1) .....	54
Q54: RF Low Battery Reports to CS (0-1) .....	54
Q55: Opening Reports to CS (0-1) .....	54
Q56: Closing Reports to CS (0-1) .....	54
Q57: Alarm Restore Reports to CS (0-1) .....	54
Q58: Trouble Restore Reports to CS (0-1) .....	54
Q59: Bypass Restore Reports to CS (0-1) .....	54
Q60: AC Restore Reports to CS (0-1) .....	54
Q61: System Low Battery Restore Reports to CS (0-1) .....	54
Q62: RF Low Battery Restore Reports to CS (0-1) .....	54
Q64: Smart Test Reports .....	55
Q65: RF Jam Causes Trouble (0-1) .....	55
Q66: Daylight Saving (0-1) .....	55
Q67: Daylight Saving Start Month (01-12) .....	55
Q68: Daylight Saving Start Monday (1-7) .....	55
Q69: Daylight Saving End Month (01-12) .....	55
Q70: Daylight Saving End Sunday (1-7) .....	55
Q71: System Tamper Causes Trouble (0-1) .....	55
Q72: Quick Bypass (0-1) .....	55
Q73: Disarming Keyfob After Alarm (Alert) (0-1) .....	55
Q74: Keyfob Arm/Disarm Confirmation (0-1) .....	55
Q75: Auto UnBypass for Manual Bypass (0-1) .....	56
Q76: Force Bypass Reports (0-1) .....	56
Q77: Event Log (0-3) .....	56
Q79: Z-Wave Feature (0-3) .....	56
Q80: Z-Wave Switches Feature (0 to 1) .....	56
Q81: Z-Wave Thermostats Feature (0 to 1) .....	56
Q82: Z-Wave Door Locks Feature (0-1) .....	56
Q83: Select Temperature Display Units (0-1) .....	56
Q84: Services Require Master Code (0 to 1) .....	56
Q85: Master User Access to Z-Wave Toolbox (0-1) .....	57
Q86: Disable Siren After Two-Way Audio (0-1) .....	57
Q87: Keyfob/Remote Arming Mode on System Not Ready (0-2) .....	57
Q89: Allow Backlight Always On (Demo Mode) (0-1) .....	57
Q90: Energy Feature (0 to 1) .....	57
Q91: Radio Modem Supplier .....	57
Q92: Select Network Device (0 to 1) .....	57

Q93: Enter Broadband Network Failure Time (1-255) .....	58
Q94: Select Broadband Network Failure Causes Trouble (0 to 1) .....	58
Q95: Select Broadband Network Failure Reports (0 to 1) .....	58
Q96: Select Send Report 3 Times on Panel Tamper (0 to 1) .....	58
Q97: Select Sound on Normal Closing Acknowledgment (0 to 1) .....	58
<b>Final Installation Setup .....</b>	<b>59</b>
Exiting Programming (System Configuration) .....	59
Access the Installer Toolbox .....	61
Disable/Enable Sounder .....	61
Disable the Sounder .....	61
Enable the Sounder .....	61
Sensor Type (Zone) Report Test .....	61
Walk Test .....	61
Radio Status Test .....	62
Cell Phone Test .....	62
Restore Default System Configuration .....	63
Soft Reset .....	63
Hard Reset .....	63
<b>Regulatory Information .....</b>	<b>64</b>
Wireless Product Notice .....	64
FCC Notice .....	64
Industry Canada Notices .....	64
Commercial Regulatory Listings .....	65
<b>Limited Warranty .....</b>	<b>66</b>

# Introduction

## About this Guide

This guide provides distributors, dealers, and authorized installation personnel with information about installing, testing, and maintaining the 2GIG Go!Control system. 2GIG products are not sold directly to consumers and can only be obtained from authorized distribution channels. For a list of authorized distributors, visit: <http://www.nortekcontrol.com>

## About the 2GIG Go!Control System

Depending on the options set during the installation, the 2GIG Go!Control system has the ability to provide three forms of protection: burglary, fire, and emergency. The system consists of the 2GIG Control Panel, wireless sensors for perimeter and interior burglary protection, and wireless smoke and carbon monoxide detectors. In addition, optional remote control key fobs, wireless panic buttons, and keypads may also be installed.

The system monitors all protection sensor types (a.k.a., “zones”) and the system’s status. The Control Panel displays monitoring information and controls the alarm siren. The system can also be setup to send alarm and status reports to a Central Station and has the capability for two (2)-way voice communications with the Remote Service Provider (RSP).

When a security system is installed, insurers may offer discounts on the homeowners’ or renters’ insurance policy. Although the requirements and discount credits vary for each different insurer, users can generally save money as the level of protection increases. It is recommended that you inform the end user to check with their insurance agent to determine if the insurer has specific requirements and/or offers any discount(s).

## Important Information

The 2GIG Go!Control security system conforms to the Security Industry Alarm Coalition’s *ANSI/SIA CP-01: Control Panel Standard-Features for False Alarm Reduction*. It also meets the residential security system certification criteria for the ETL Listed Mark.

The recommended storage temperature for all Control Panels is -10°C to 60°C (14°F to 140°F). For optimal Control Panel use, operation temperature is 0°C to 49°C (32°F to 120°F). No altitude range limitations have been reported while transporting Control Panel.

## Installing the System in Residential Settings

When installing the system in a residential setting, be aware of the following:

- **Fire warning systems must be installed in accordance with national codes.** In the United States, fire warning systems must be installed in accordance with *ANSI/NFPA 72 National Fire Alarm and Signaling Code* and *ANSI/NFPA 70 National Electric Code*.
- **A permit may be required for this alarm system.** Some cities and municipalities may require an alarm system permit. Before installing this system, always ensure that you are in compliance with any national, regional, and local laws, rules, and/or guidelines.
- **This system is intended for use with approved-model smoke alarms only.** For use as a smoke alarm system, there must be at least one (1) smoke alarm programmed into the Control Panel and must use only approved model smoke alarms. Visit the 2GIG Dealer Web Site at [dealer.2gig.com](http://dealer.2gig.com).
- **Failure to follow ETL requirements voids this system’s ETL Listed mark.** Failure to install the Control Panel and accessories in accordance with the ETL requirements documented in this manual voids its ETL Listed Mark.





## Installing the System in Commercial Settings

When installing the system in a commercial setting, be aware of the following:

- **The system cannot be used for fire protection in commercial settings.** In a commercial setting, it is important to know that the Control Panel is neither designed nor intended for use as a fire protection system.
- **The system is intended only for security protection of premises.** In a commercial setting, this system is only intended for protection of commercial premises, such as a mercantile or office. It is neither designed nor intended to protect commercial bank vaults.
- **A permit may be required for this alarm.** Some cities and municipalities may require an alarm system permit. Before installing this system, always ensure that you are in compliance with any national, regional, and local laws, rules, and/or guidelines.

## System Features

The 2GIG Go!Control system offers security protection for your property, 24-hour emergency monitoring, and can optionally be used for fire detection in the home. Features include:

- **Full Voice Response.** The panel gives clear notifications that indicate system status, zone descriptions, alarms, and emergencies.
- **Date, Time, and Weather Display.\*** Scroll through the date, time, and daily weather forecast. Provides the ability to receive messages, including severe weather warnings.
- **Quick Access.** The one touch access buttons allow the quickest help possible in an emergency. The front panel  and  buttons serve as controls as well as indicators. Pressing the  button displays emergency icons on the display for Panic, Fire, and Emergency alarm activation (each has programmable options and can be enabled or disabled). Pressing the  button changes the system display to the Home screen.
- **Full Color Touch Screen.** Control all system functions with an easy-to-use color touch screen puts a wide range of security and home automation controls at your fingertips.
- **Multiple Arming Options.** Secure your home by arming your system “AWAY” or “STAY”. The Quick Arm/Exit and Bypass features offer added convenience.
- **Home Automation Radio Module.** The built in Z-Wave radio enables various home automation functions including HVAC, appliances, lighting, and lock control.
- **Two (2)-way Response Over Cellular.\*** Two-way voice lets central station operators listen in and talk to you when a signal is received, ensuring that the proper emergency response personnel will be dispatched if necessary.
- **Fully Self-Contained.** The fully self-contained panel contains a backup battery, and allows 60 user codes and monitors up to 60 wireless zones including eight (8) key fobs and four (4) keypads. It also provides two (2) hardwired loops, 15 sensor types, a supervised bell output, and a programmable solid-state control output.
- **Over-The-Air (OTA) Updates.\*** There’s no need to worry about the panel’s software becoming outdated. With the OTA function, the panel can be remotely updated with the latest software.
- **Remote Control Options.\*** Always be in control by remotely managing your system from a computer or web enabled mobile phone (iPhone, Android, etc.).
- \* Feature requires the optional LTE (Cellular) Radio module and an active account with an Remote Service Provider.

## Optional Accessories

Optional modules, keypads, radios, and sensors that can be purchased to enhance the system include:

- **2GIG LTE (Cellular) Radio Module.** An on-board digital communicator reports alarms and trouble to a Central Station receiver and a two (2)-way voice communication with the Central Station. It also supports OTA updates and remote control of the system using a Web-enabled device through the Internet.
- **2GIG 900 MHz Transceiver Module.** It sends and receives signals with wireless touch screen keypads and image sensors. Touch screen keypads allow remote control of the system through the same graphic interface design as the 2GIG Control Panel. Note that the 2GIG 900 MHz Transceiver Module, touch screen keypad, and image sensor are only available in some regions.
- **2GIG Wireless Touch Screen Keypad.** A wall-mounted, full-color, touch screen interface that provides many of the same easy-to-use keypad functions available on the Control Panel. It is designed for indoor use only and gives users the ability to control lights, thermostats, and door locks, as well as to view the status of every sensor zone. When the 2GIG 900 MHz Transceiver Module is installed in the Control Panel, the system can be programmed to communicate with up to four (4) Wireless Touch Screen Keypads.
- **2GIG Go!Bridge IP Communicator.** The Go!Bridge provides Internet connectivity between the monitoring service's Central Station and the Go!Control® Panel (requires the 2GIG 900 MHz Transceiver Module and supports automatic firmware updates, provides interactive security services, and increases supervision using signal-forwarding to the Central Station.
- **2GIG Super Switch Takeover Module.** The takeover module communicates with the 2GIG Control Panel and is designed to convert up to eight (8) pre-wired zones to supervised wireless zones.
- **2GIG Hardwire Conversion Kit.** This kit provides installers with an easy way to convert the zones of a pre-wired security alarm system to 2GIG wireless zones. The kit includes one (1) Super Switch Takeover Module (Wireless Takeover of an Alarm System, US Patent No. 8,638,218). You can also install two (2) additional modules, which provides installers with the capability to convert up to 24 pre-wired security zones to wireless zones.



# System Configuration

This illustration details the entire system configuration (including optional features). See [“Optional Accessories” on page 6](#).

**Figure 1 Complete System Configuration**

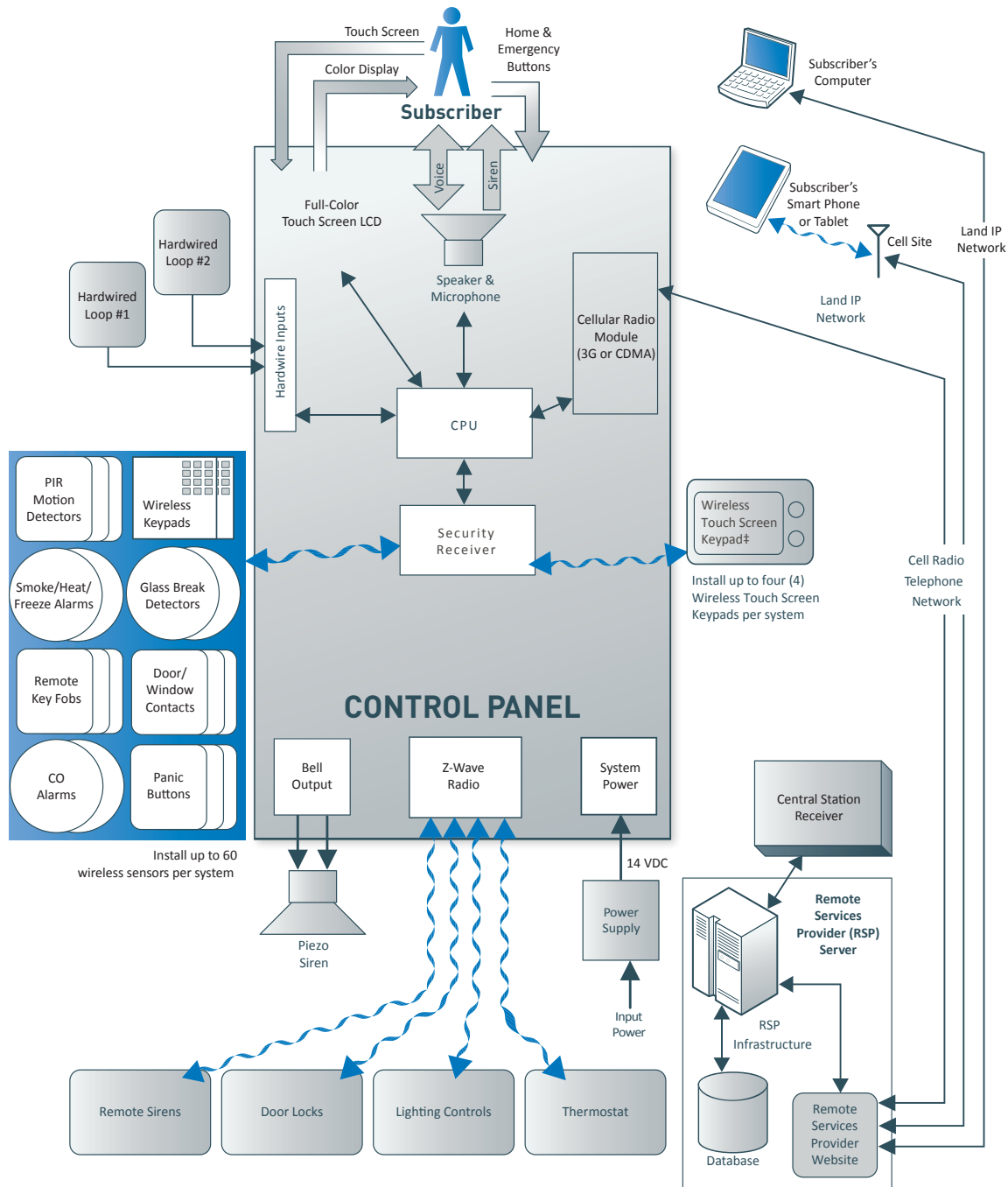

# Control Panel Features

## External Features

Figure 2 Control Panel External Features

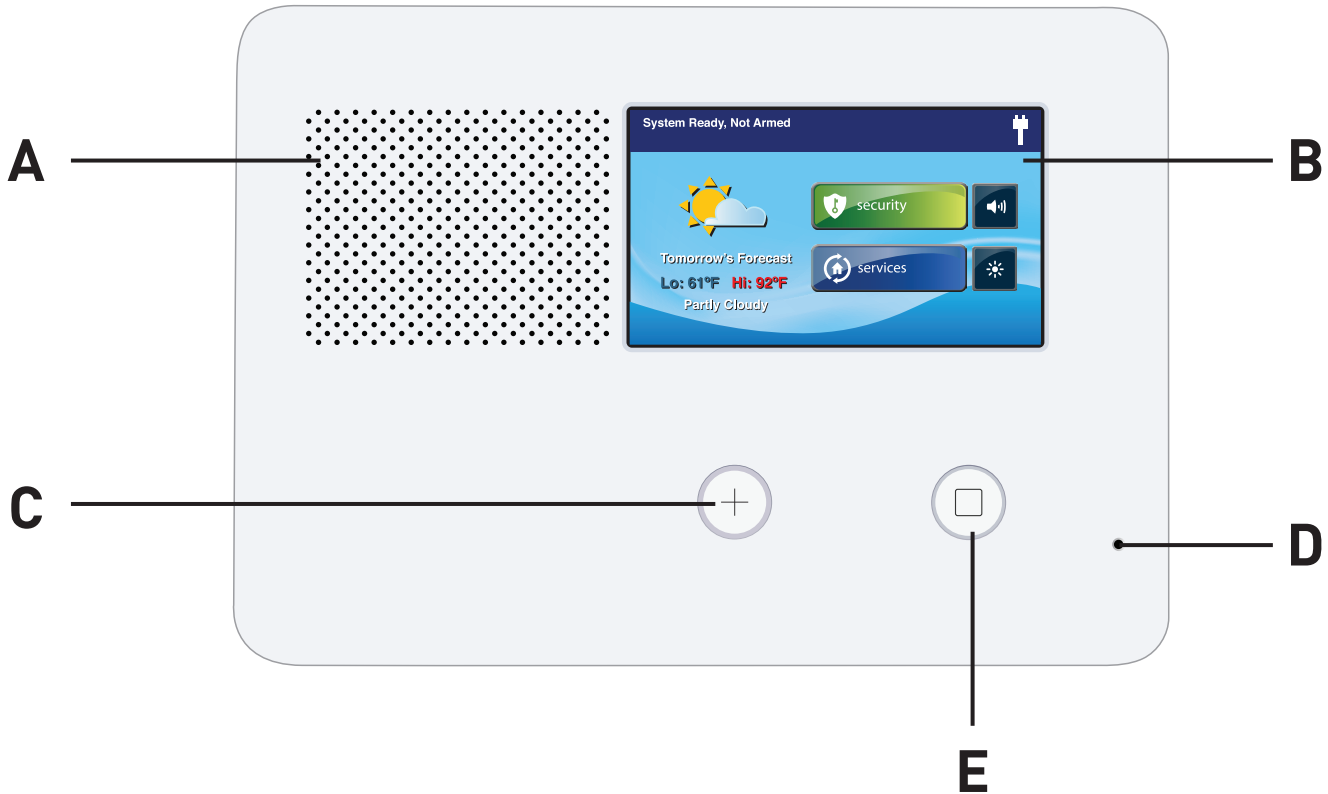

<b>A Alarm Sounder and Speaker</b>	Sounds all system local alarms, voice prompts, system sounds, and audio for two (2)-way voice communications with the Central Station
<b>B Color Display with Touchscreen</b>	Shows all system information, status, programming, and functions as the keypad. Display cycles clock, calendar, and weather with an Alarm.com account (tap manually to change)
<b>C Emergency Button/Indicator</b>	Lights WHITE when enabled for emergency alarms and flashes during emergency alarms
<b>D Microphone</b>	For voice communication with the Central Station
<b>E Home Button/Indicator</b>	<p><b>Sensor Status</b>                  Lights BLUE when all sensors are closed (ready to arm)                  Not lit when any sensor is open (not ready to arm)</p> <p><b>Arming Status</b>                  Lights RED when system is armed                  Flashes RED during the Entry Delay</p> <p><b>Alarm Memory</b>                  Flashes RED during an alarm                  Flashes RED after an alarm while system is still armed</p> <p><b>Power Outage</b>                  Flashes WHITE during power outage (system on battery backup)                  Flashes BLUE when all sensors are closed (ready to arm)                  Flashes ORANGE when any sensor is open (not ready to arm)                  Flashes RED while system is armed</p>

## Internal Features

Figure 3 Control Panel Internal Features

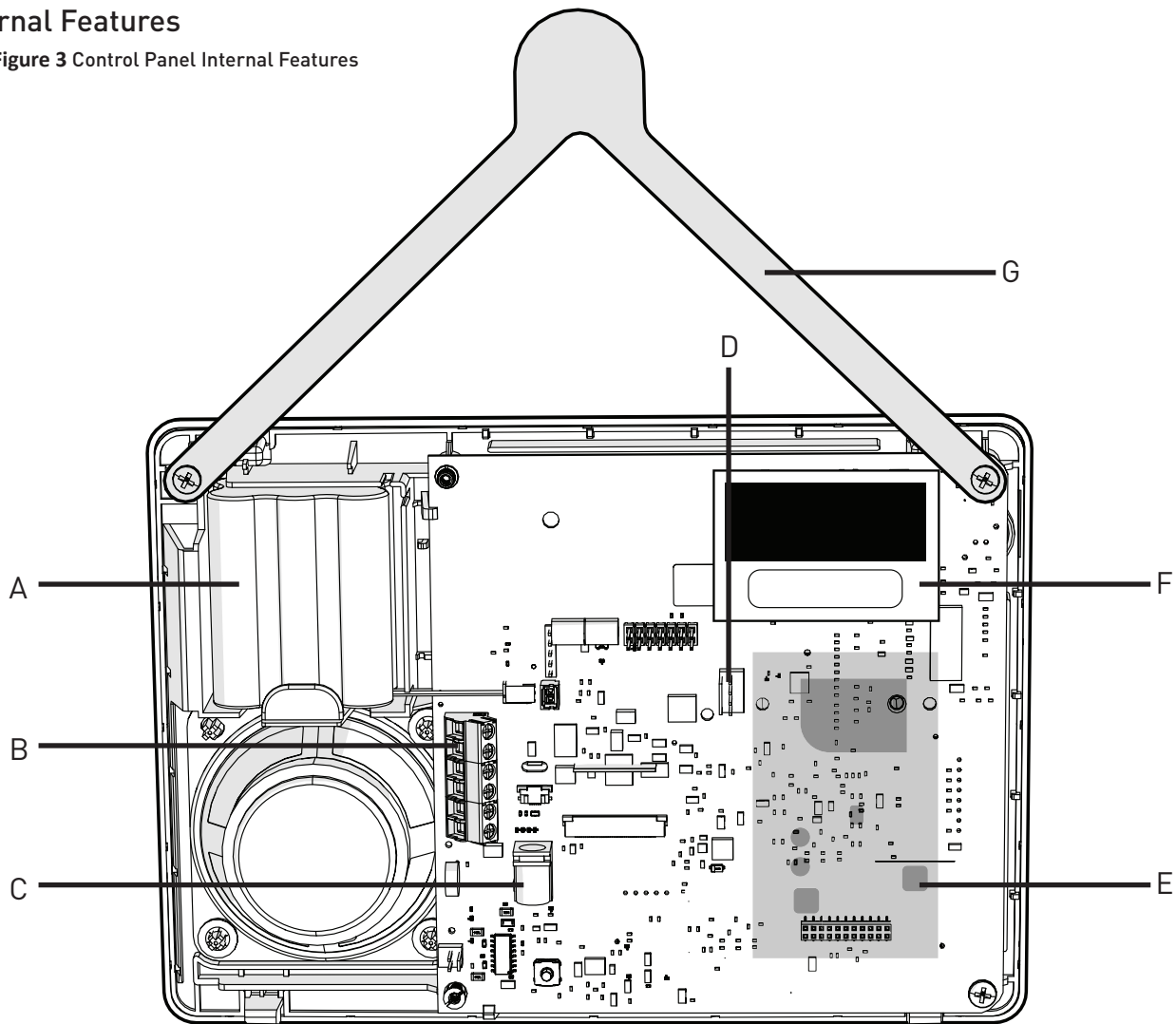

A	<b>Backup Battery Pack</b>	The standard backup battery that is included with all 2GIG Control Panels does not support UL 985 installations. To comply with the secondary supply requirement in UL 985 Household Fire Warning System Units, you must install the 2GIG Console Battery Pack (2GIG-BATT2X).
B	<b>Terminal Block</b>	Connections for power, solid state output bell, and hardwire loops.
C	<b>Alternate Power Supply</b>	Alternate connection for power. (Plug-in barrel connector)
D	<b>J4 Pin Connector</b>	Connector for the Firmware Update Cable used to update the firmware version on the Control Panel.
E	<b>Cell Radio Module</b>	2GIG Go!Control Module for over-the-air communication with the Central Station.
F	<b>Main Receiver Module</b>	Receiver for peripheral device transmissions (or an optional 2GIG 900 MHz Transceiver Module for use with the Wireless Touch Screen Keypad).
G	<b>Third-Hand Hanger Strap</b>	Hooks onto mounting plate during installation to hold the Control Panel while wiring.

## Installation Outline

Use the following outline in conjunction with this *Installation and Programming Guide* to guide you through the installation steps.

1. Unpack the system and identify the system components.
2. Create an Installation Floor Plan to determine the best centralized location for the Control Panel.
3. Decide where to best install the wired and/or wireless sensors. Guidelines are available in the Installation Instructions included with each sensor.
4. Identify an unswitched wall outlet to use for the Control Panel's power supply.
5. (Optional) Install the LTE (Cellular) Radio Module in the Control Panel. See [“LTE \(Cellular\) Radio Module” on page 15](#).
6. Use the Control Panel's backplate to mark the drywall cutouts for the Control Panel. Then make the cutouts and attach the backplate to the wall. See [“Control Panel Mounting Plate” on page 13](#).
7. Install each of the system's wireless sensors. If the hardware zone is used, install the contacts and route the loop wire to the Control Panel's wall cutout.
8. Install the optional hardwired sounder, and route the connection wire to the Control Panel's wall cutout.
9. Use the third-hand hanger strap to hang the Control Panel on the mounting plate. Then connect all wiring to the Control Panel's terminal block. See [“Control Panel Wiring” on page 17](#) and [“Terminal Block Wiring Diagram” on page 17](#).
10. Plug the backup battery connector into the connector on the circuit board.
11. Swing the Control Panel up, placing the bottom over the lip of the mounting bracket. Push the top of the Control Panel into the mounting bracket until it snaps into place, then secure it with the retaining screw.
12. Plug the power supply into the unswitched wall outlet.
13. Program the system as described in this manual and document any custom setup options for the end user in the space provided in the User Guide.
14. Test the system as described [“Installer Testing” on page 61](#).
15. Educate the end user(s) about basic system operations and provide them with the Control Panel's User Guide.

# Wireless Installation Tips

When installing any wireless system, consider certain limitations. Low power wireless transmitter signals do NOT broadcast equally through all types of construction materials. However, the Control Panel does contain a sensitive receiver that typically allows for placement of transmitters in nearly all locations. To determine the best possible placement for wireless sensors, review the following illustration.

Figure 4 Wireless Installation Tips

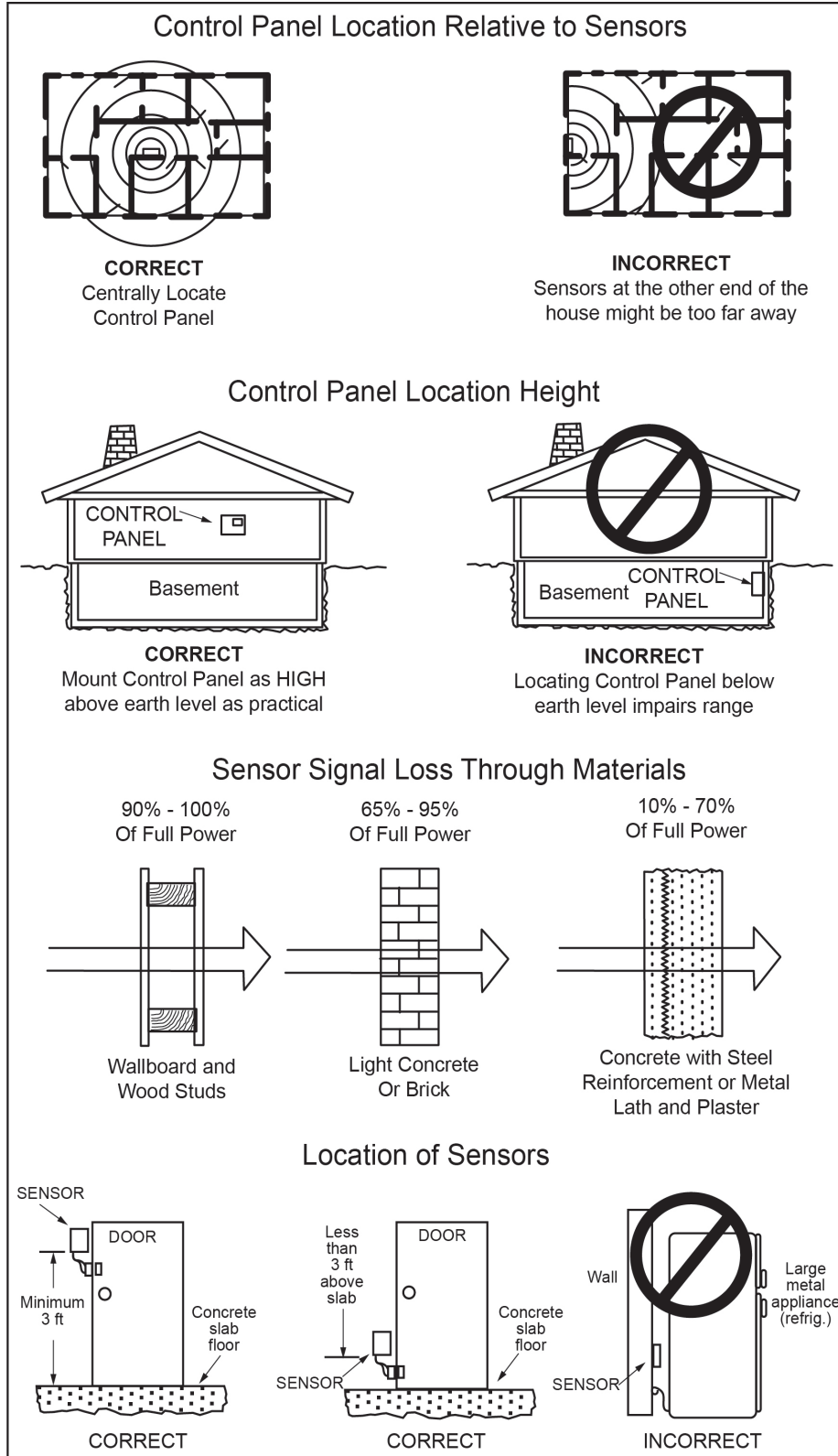

## Sensors and Accessories

### Wireless System Sensors

- Thin Door/Window Contact
- Recessed Door Contact
- Passive Infrared (PIR) Motion Detector
- Four (4)-Button Keyfob Remote
- Panic Button Remote
- Glass Break Detector
- Wireless Smoke/Heat Alarm
- Wireless Touch Screen Keypad
- Wireless Keypad
- Super Switch Takeover Module (Wireless Takeover of an Alarm System, US Patent No. 8,638,218)

### System Accessories

- LTE (Cellular) Radio Module
- Internal Antenna
- External In-Wall Antenna
- External Attic Mount Antenna
- Standard Battery Pack (UL 1023)
- Extended Battery Pack (UL 985)
- Replacement Power Supply
- Go!Bridge™ IP Communicator
- Hardwire Conversion Kit

# Installation

## Control Panel Mounting Plate

Mount the Control Panel on the wall in a convenient location (or use the optional desk mount). These tools may be required to mount the Control Panel onto the wall:

- Screwdriver
- Wire Stripper
- Staple Gun
- Drywall Saw (or equivalent)
- Ladder

1. To remove the optional desk mount, press the inward on the tabs connecting the base and panel.
2. Hold firmly, then use your fingernail to detach and remove the panel faceplate (A).
3. Unlock the two captive screws (B) and two latches (C) with a small flathead screwdriver to separate the panel (D) from the bottom mounting plate.
4. Depress the two tabs and pull apart to unlock the unit from the mounting plate.
5. Use the level on the mounting plate, then mark the wall for the wiring cutout slot. Use a drywall saw to cut the slot.
6. If using the optional LTE (Cellular) Radio Module with an external antenna, remove the plastic knockout labeled “(( ))” on the mounting plate (E). Mark and cut a slot in the drywall for the external antenna.
7. Attach the mounting plate to the wall using four (4) screws.
8. Remove the two top screws from the Panel, then replace the screws attaching the Hanger (G).
9. Hang the panel from the mounting plate.

Figure 5 Control Panel Mounting Procedure

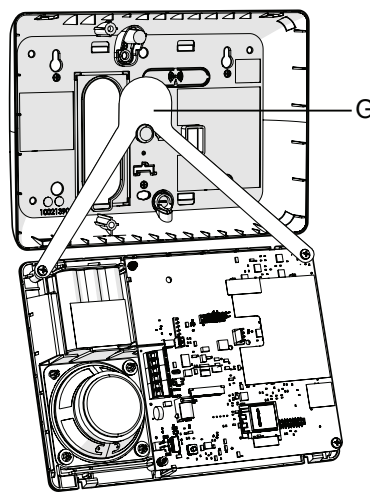
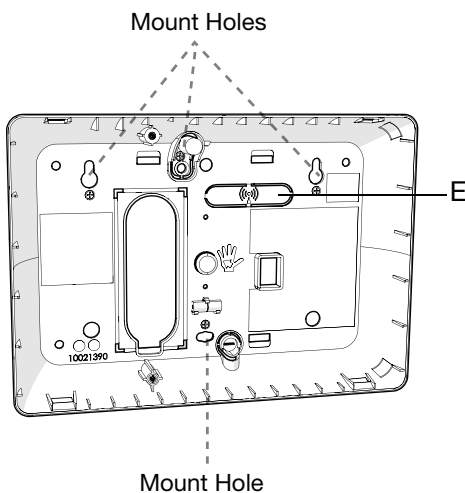
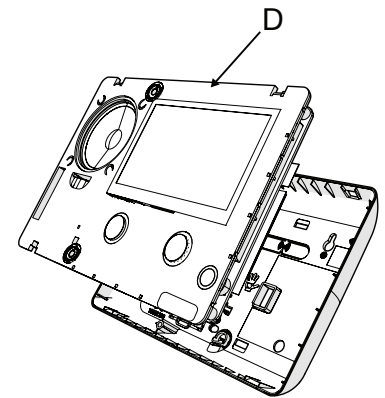
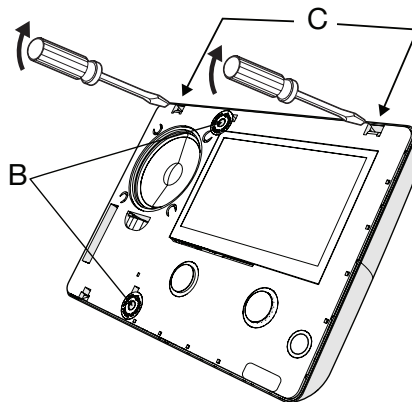
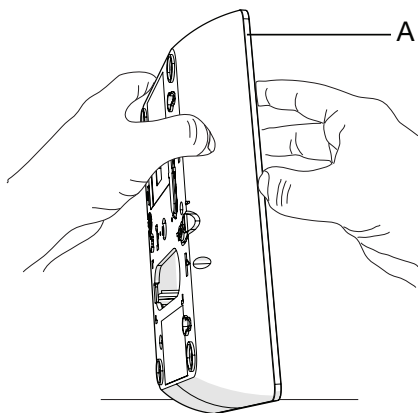
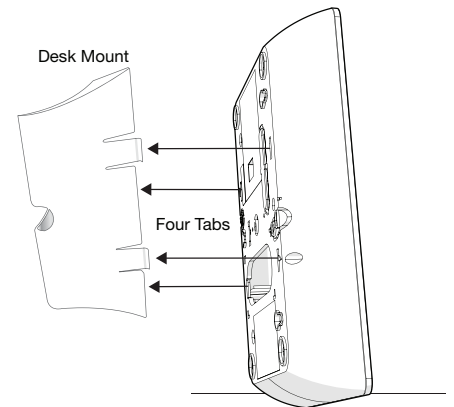

A	Remove Face Plates
B	Unlock Locking Screws
C	Unlatch Latches
D	Remove from Mounting Plate
E	If using external antenna, remove knockout plate. Use mounting plate as a template to mark wire cutout hole in dry wall (four screws).
G	Hanger

## Wireless Sensors

Install wireless sensors in the appropriate location using the *Installation Instructions* included with each wireless sensor as a guide.

## Hardwired Loops

Hardwired loops can be programmed either Normally Open (N/O) or Normally Closed (N/C). End-of-Line Resistors (EOLR) can also be used to supervise the loops. Only contacts should be used with the hardwired loops.

**NOTE:** The Control Panel does not support powering external devices (PIR's, etc.).

**NOTE:** Hardwired loops cannot be used for a CO or Fire sensor loop.

1. If either of the two (2) hardwired loops are going to be used, install the contacts and then route the loop wire to the Control Panel's wall cutout.
2. If end-of-line supervision is required for the loop, install a 2.2kΩ resistor (not supplied) as shown in *Figure 6 Hardwired Loop Wiring*.

## Wiring

Hardwired loops need to be programmed for contact type.

**Figure 6 Hardwired Loop Wiring**

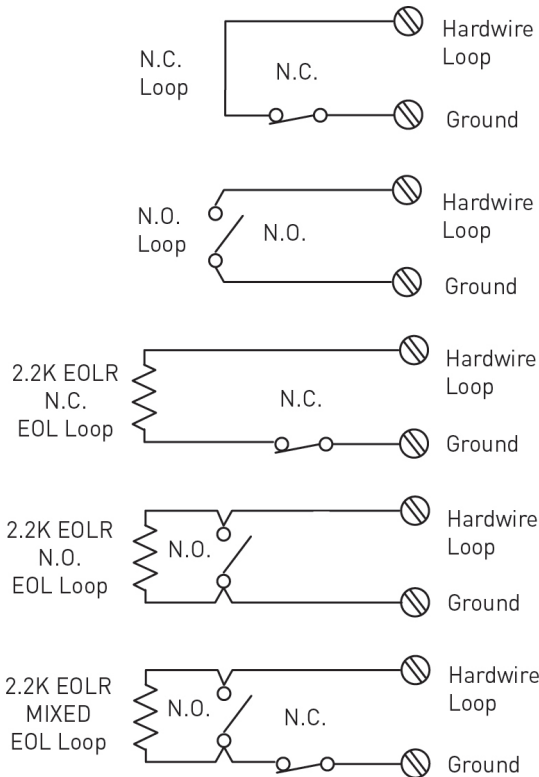

**WARNING:** Stranded conductors clamped under wire-binding screws or similar parts shall have the individual strands soldered together or arranged in a construction that has been determined to be the equivalent.

## Remote Alarm Sounder

The Control Panel provides two (2) terminals for an optional connection to a remote electronic alarm sounder.

**Figure 7 Remote Alarm Sounder**

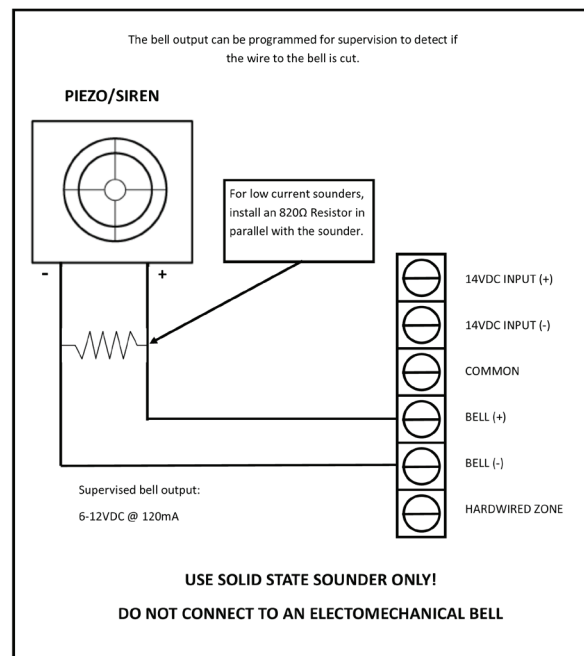

**WARNING:** To avoid damage to the output, do NOT connect an electromechanical bell to these terminals.

The bell terminals can be supervised. If *Q21: Siren Supervision Time* is set to (1) *Enabled*, and the wire between the Control Panel and sounder is cut, the Control Panel displays a trouble alert message for siren supervision and sends a bell trouble report to the Central Station.

1. Install the remote sounder in a secure location where it will be easily heard by occupants.
2. Route wiring from the remote sounder location to the Control Panel's wall cutout.

**NOTE:** If the Piezo alarm siren for the remote sounder has an extremely low current draw or the sounder produces hum or noise, install an 820Ω resistor in parallel with the sounder.



1. Power ON the Control Panel.
2. Access the System Configuration screen as follows:
  - a. At the Home screen, tap the system logo in the lower-right corner.
  - b. At the Enter Your Code screen, enter the master installer code (the default code is 1561).
  - c. At the Installer Toolbox screen, tap System Configuration.
  - d. Tap Go To and then enter the code shown below to respond to these programming questions:
    - Enter **08**.
    - Enter **11**.
    - Enter **12**.

**IMPORTANT:** You must program the module in order to use it with the Control Panel.

## LTE (Cellular) Radio Module

If installing the LTE (Cellular) Radio Module, see below:

**Figure 9** In-Wall Antenna Installation

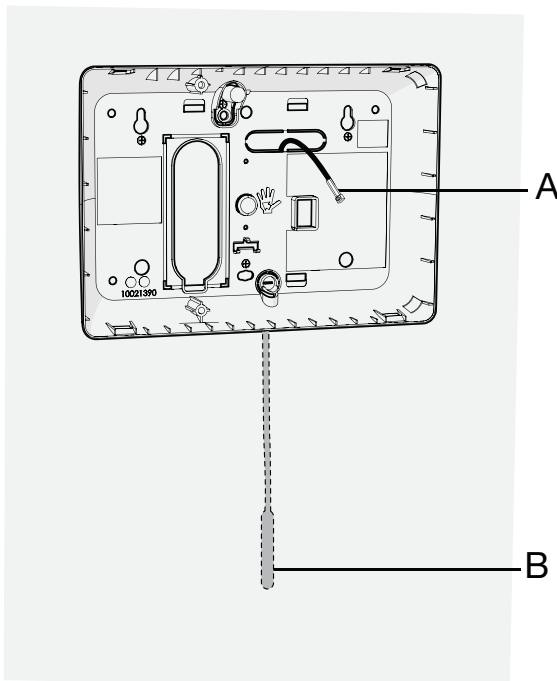

- |   |   |
|---|---|
| A | LTE (Cellular) Radio Module Connector     |
| B | End of antenna hangs down inside the wall |

**NOTE:** The routing of the antenna wire is critical. **You must route the wire exactly as directed or cell radio interference will occur.**

1. When using external antennas, plug the antenna connector into the LTE (Cellular) Radio Module. The antenna drops into the wall or mounts in the attic with the cable passing through the slot in the Control Panel's mounting plate.

**Figure 8** Attic Antenna Installation

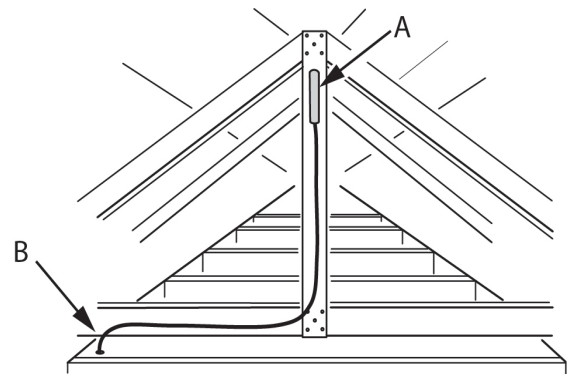

- |   |   |
|---|---|
| A | Attic antenna mounted as high as possible |
| B | Coaxial cable to Control Panel            |

The LTE (Cellular) Radio Module should already be activated by the factory. If not, contact the Remote Service Provider. For the LTE (Cellular) Radio Module to function, it must be activated before it can be enrolled. Enrollment is accomplished by creating an account with the provider.

## Control Panel Wiring Diagram

The following diagram shows you the Control Panel wiring.

Figure 10 Control Panel Wiring Diagram

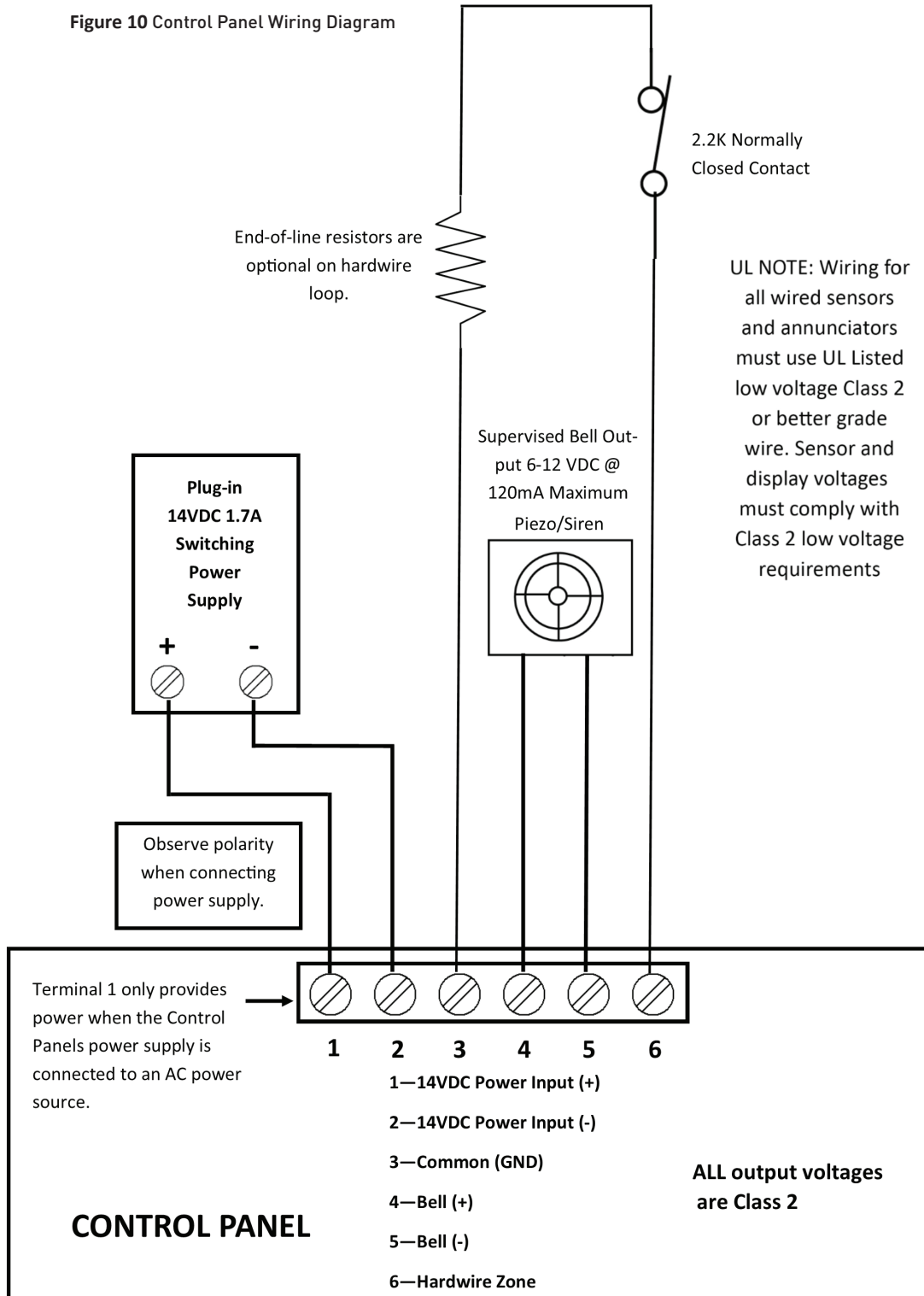

## Control Panel Wiring

The third-hand hanging strap allows you to hang the Control Panel on the mounting plate during installation.

1. Hang the Control Panel on the mounting plate by the third-hand hanger strap.
2. Connect the hardwire loop and external sounder to the Control Panel's terminal block.

Figure 11 Third-Hand Hanging Strap

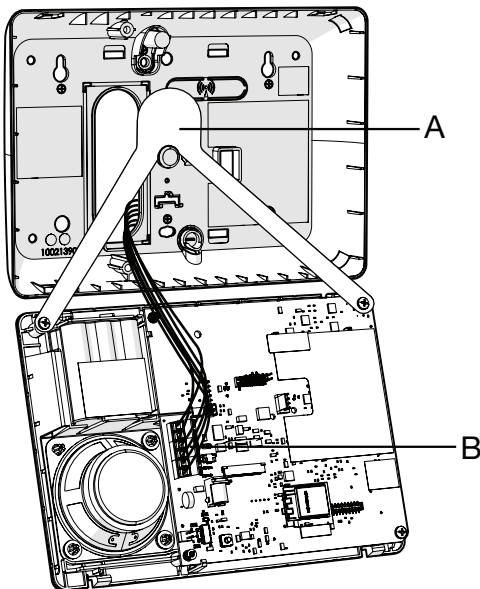

- |   |   |
|---|---|
| A | Third-hand hanging strap                                    |
| B | Hardwire loops and external sounder connected to terminals. |

## Terminal Block Wiring Diagram

Figure 12 Terminal Block Wiring Diagram

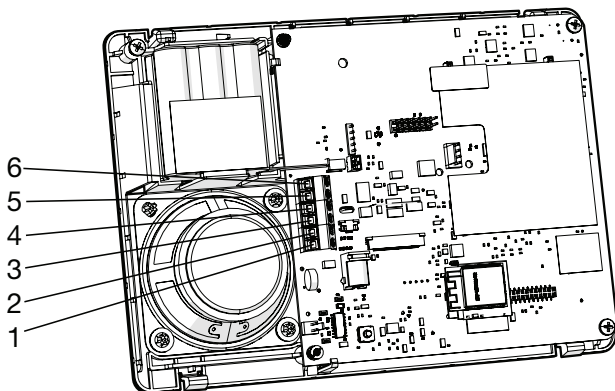

- |   |                        |
|---|------------------------|
| 1 | 14 VDC Power Input (+) |
| 2 | 14 VDC Power Input (-) |
| 3 | Common Ground (GND)    |
| 4 | Bell (+)               |
| 5 | Bell (-)               |
| 6 | Hardwired Zone         |

## Backup Battery Connection and Power Supply Wiring

The backup battery connects to the Control Panel's circuit board with a two (2)-pin header assembly.

The power supply features a two (2)-position terminal block for connecting the power supply to the Control Panel power terminals (connection wire not included).

1. Locate an unswitched wall outlet for the plug-in power supply.

**WARNING:** Never connect the power supply to switch-controlled outlet.

2. Route two (2)-conductor wire from the power supply location to the Control Panel mounting plate. For wire size and maximum length, see "Wired Size and Length", below.
3. Being careful to observe polarity, connect the wire to the power supply's DC+ and DC- terminals. Do NOT plug the power supply into an outlet at this time.
4. Being careful to observe polarity, connect the wire to the Control Panel input terminals 14VDC (+) Terminal 1 and 14VDC (-) Terminal 2.

**NOTE:** Grounding of the Control Panel is NOT required for proper operation.

5. Plug the backup battery pack's connector into the connector on the Control Panel's circuit board. The Control Panel does not recognize that the battery is connected until AC power is connected to the power supply.

**NOTE:** The standard backup battery that is included with all 2GIG Control Panels does not support UL 985 installations. To comply with the secondary supply requirement in *UL 985: Household Fire Warning System Units*, install the 2GIG Console Battery Pack (This is a high-capacity 2600mAh Ni-MH replacement battery pack).

## Wire Size and Length

To ensure proper operation, do NOT exceed the following maximum length for the wire size installed:

Wire Size	Maximum Length
22 AWG	55 ft (16.8)
20 AWG	85 ft (25.9 m)
22 AWG 2-pairs (19 AWG equivalent)	110 ft (33.5 m)
18 AWG	135 ft (41.1 m)

**TIP:** To ensure that the appropriate wire size and length is installed, measure the voltage between the power connection terminals at the back of the Control Panel. The voltage measured must not fall below 11 volts DC or the Control Panel may display nuisance "AC Power Loss" messages and send AC Loss Reports to the Central Station. See "Q52: AC Loss Reports to CS (0-1)" on [page 53](#).

**NOTE:** In the United States, wiring routed inside walls, ceilings, and floors must comply with requirements of *ANSI/NFPA 70: National Electrical Code (NEC)* and local building codes. For wiring from the output of the 2GIG Class II Power Supply, wiring rated CL2, CL2X, CL2R, or PLTC is recommended to satisfy these requirements. If this wiring is installed in an air plenum (space used for environmental air exchange) it must be rated CL2P (plenum-rated).

Figure 13 Power Supply Wiring

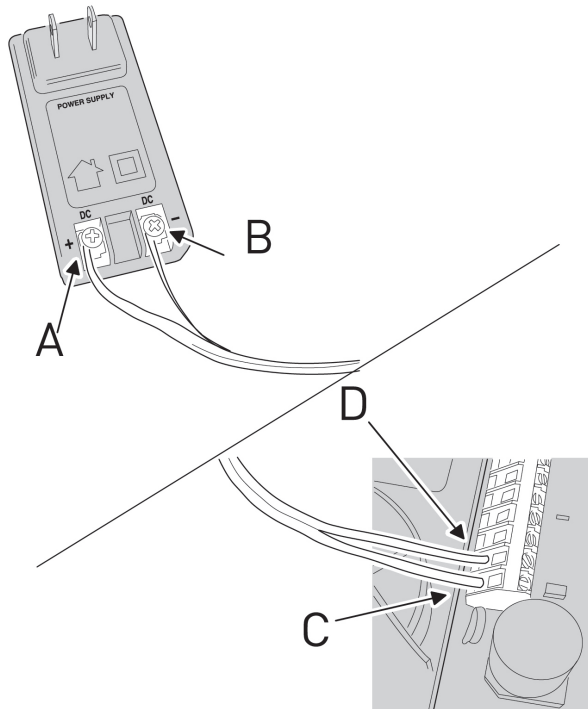

A	Left Terminal 14 VDC (+)	C	14 VDC (+) Terminal 1
B	Right Terminal 14 VDC (-)	D	14 VDC (I) Terminal 2

### Control Panel and Power Supply Mounting

After all the wiring complete, follow these steps to power up the Control Panel:

1. Place the bottom of the Control Panel over the lower lip of the backplate and flip the Control Panel upwards. Then push the Control Panel over the mounting bracket until it snaps into place, then secure it with the retaining screw.
2. Peel off the adhesive backing from the power supply retaining bracket and attach the bracket to the outlet with a wall plate screw.

Figure 14 Connecting Battery and Closing Panel

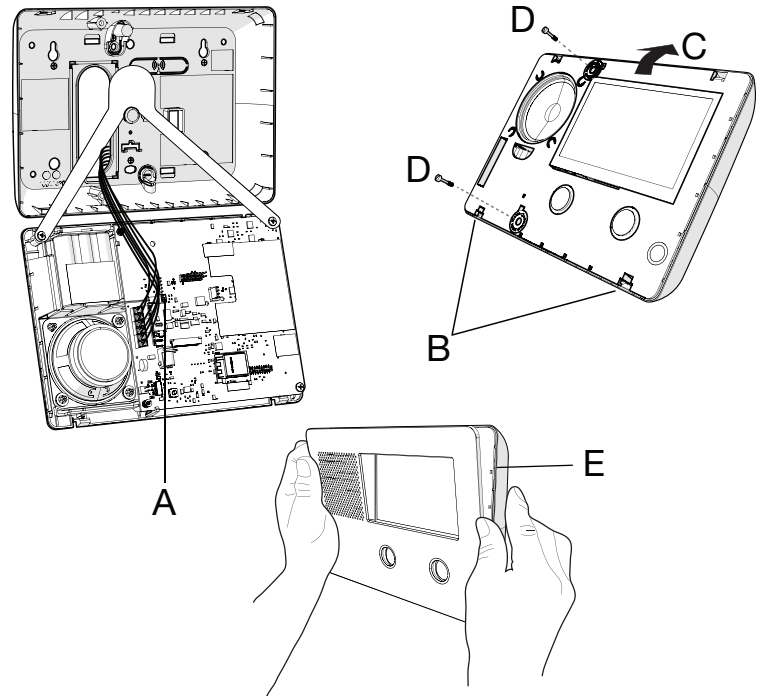

A	Connect battery
B	Align mounting plate tabs inside of console bottom edge
C	Swing console up and snap into the mounting plate
D	Secure console with two screws in retaining mode
E	Align face plate and press into place

3. Spread the retaining bracket ears and plug the Control Panel's power supply into the unswitched wall outlet. Slots are provided on the bracket to secure the power supply with a zip-tie.
4. After about five (5) seconds, the Control Panel indicates that power has been applied. If the Control Panel does not power up, check the power supply polarity.

Figure 15 Securing the Power Supply

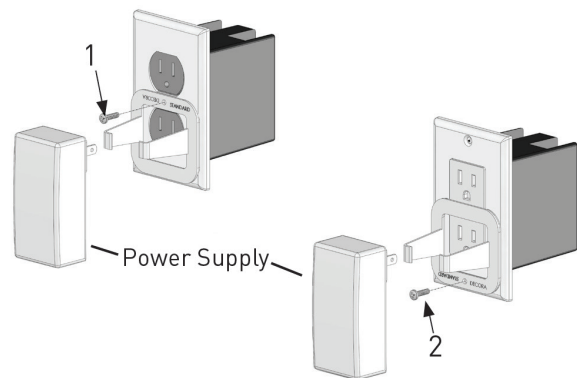

1	Place the screw here for a bracket on a standard style outlet.
2	Place the screw here for a bracket on a Decora style outlet.

**NOTE:** In the United States (and other countries where it is required), use the power supply retaining bracket. In Canada, the power supply retaining bracket is not required.

# Commercial Installations

For commercial installations, the Control Panel is designed for use only as a burglary alarm system, and not for fire protection. Installation location and wiring methods shall be in accordance with *ANSI/NFPA 70: National Electric Code*, *UL 681: Installation and Classification of Burglar and Holdup Alarm Systems*, and *UL 827: Central-Station Alarm Services*.

**NOTE:** When used with the Alarm.com service, this security system has been evaluated and complies with *UL 1610: Central-Station Burglar Alarm Units*. For commercial UL 1610 installations, you must install the LTE (Cellular) Radio Module.

See [“LTE \(Cellular\) Radio Module” on page 15](#).

**NOTE:** All entries and exits within a commercial installation setup must be protected according to the criteria provided by *UL 681: Installation and Classification of Burglar and Holdup Alarm Systems*.

Figure 16 Commercial Installations

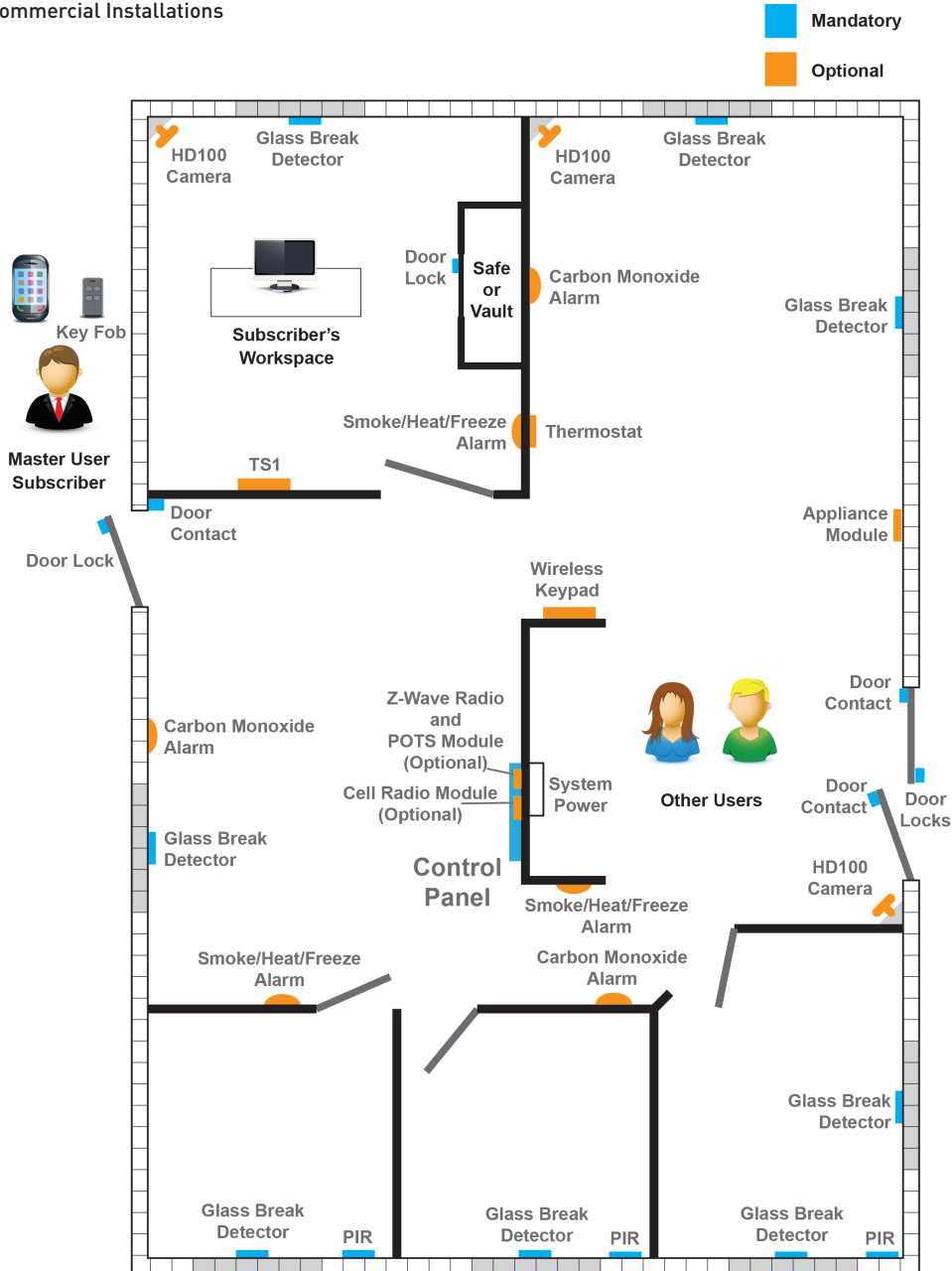

# NFPA Standard 72

In the United States and Canada, smoke detectors must be installed in accordance with *National Fire Protection Association (NFPA) Standard 72: National Fire Alarm and Signaling Code*, which reads as follows:

**2-1.1.1** Smoke alarms shall be installed outside of each separate sleeping area in the immediate vicinity of the bedrooms and on each additional story of the family living unit including basements and excluding crawl spaces and unfinished attics. In new construction, a smoke alarm shall be installed in each sleeping room.

**2-1.1.2** For family living units with one or more split levels (i.e., adjacent levels with less than one full story separation between levels), a smoke alarm shall suffice for an adjacent lower level, including basements. (Exception: Where there is an intervening door between one level and the adjacent lower level, a smoke alarm shall be installed on the lower level.)

- Ceiling mounted smoke alarms should be located in the center of the room or hall, or not less than 4 inches from any wall. When the alarm is mounted on a wall, the top of the alarm should be 4 to 12 inches from the ceiling.
- Do not install smoke alarms where normal ambient temperatures are above 100°F (37.8°C), or below 40°F (4°C). Also, do not locate alarm in front of air conditioners, heating registers, or other locations where normal air circulation will keep smoke from entering the detector.

**A-2.5.2.1** Smoke Detection - Are More Smoke Alarms Desirable? The required number of smoke alarms might not provide reliable early warning protection for those areas separated by a door from the areas protected by the required smoke alarms. For this reason, it is recommended that the residential user consider the use of additional smoke alarms for those areas for increased protection. The additional areas include the basement, bedrooms, dining room, furnace room, utility room, and hallways not protected by the required smoke alarms. The installation of smoke alarms in kitchens, attics (finished or unfinished), or garages is not normally recommended, as these locations occasionally experience conditions that can result in improper operation or false alarms”.

**NOTE:** Smoke alarms are not to be used with detector guards unless the combination has been evaluated and found suitable for the purpose.

**Figure 17 Recommended Smoke Alarm Locations**

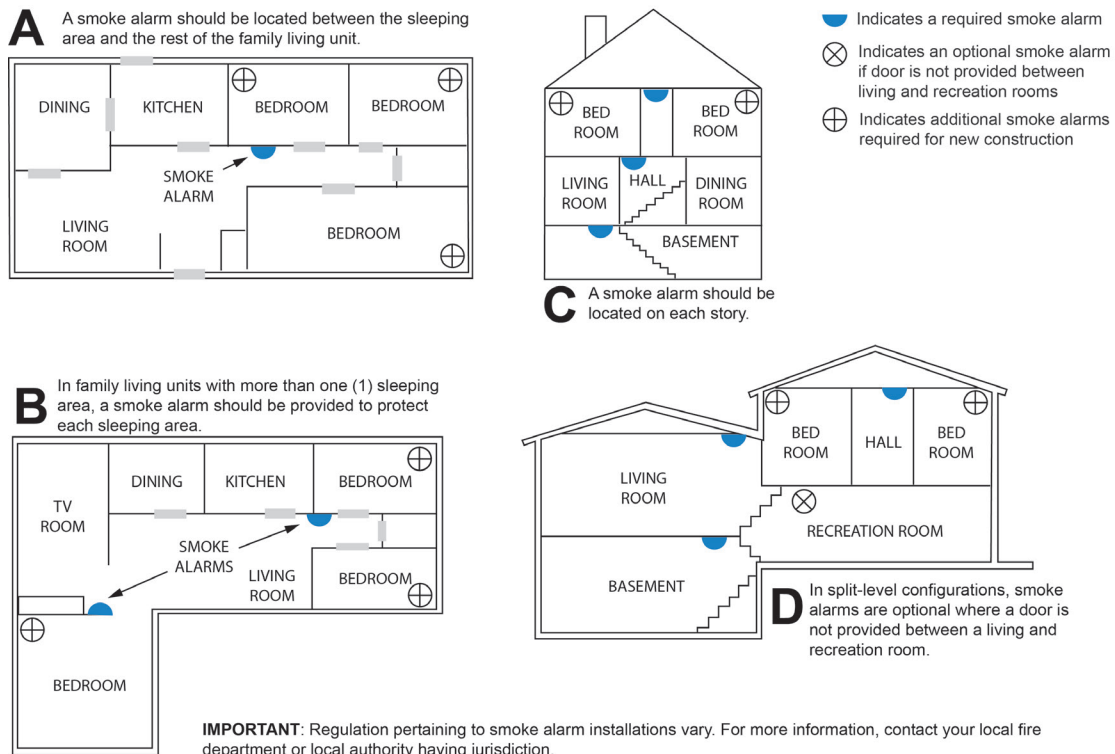

# Main Display Screens

## Home Screen

To go to the **Home** screen, press the **Home** button on the Control Panel. The Home screen reveals:

- **System Status.** The status of the system appears at the top left of the screen. For example, *System Armed* or *System Ready, Not Armed*.
- **Conditional Messages.** A variety of conditional messages will also appear under the System Status.
- **Time, Date and Weather.** The current time, date, and daily weather forecast (when the system includes the LTE (Cellular) Radio Module and has an active account with a Remote Services Provider).
- **System Status Icons.** Icons in the top-right corner reveal a variety of conditions. See [“System Status Icons” on page 25.](#)

Buttons on this page include:

- Security. Opens the Security screen. See Security Screen.
- Services. Opens the Services screen. See the Control Panel’s User Guide for more information.
- Silent Control. Opens the Bypass screen. See the Control Panel’s User Guide for more information.
- Display OFF. Turn OFF the Control Panel screen.

Figure 18 Home Screen

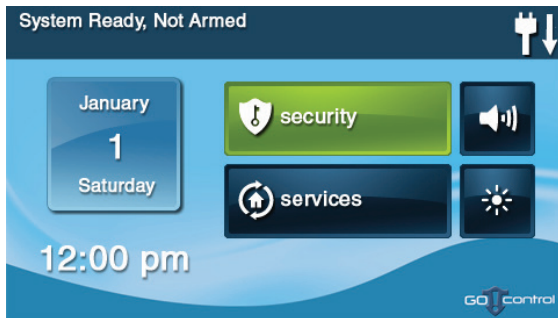

## Security Screen

The **Security** screen displays three (3) buttons for **Arm**, **Menu**, and **Status**. It also shows the time, date, and weather display (requires that the feature is supported by the Remote Service Provider).

Figure 19 Security Screen

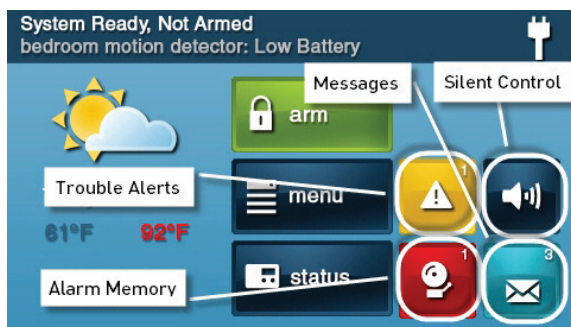

Under the appropriate conditions, additional buttons include:

- **Trouble Alerts.** Displays when trouble alerts are pending.
- **Messages.** Displays when messages are pending.
- **Alarm Memory.** Displays when alarms are pending.

For information about the **Silent Control** button, see the Control Panel’s *User Guide*.

## Arming Screen

The **Arming** screen lets users arm the security portion of the system. It displays the system status and arming buttons for **Stay** and **Away** mode. It also includes these options:

- **Entry Delay** Select this check box to arm the system with an entry delay. Clear the check box to arm the system without an entry delay. See [“01 Exit/Entry 1” on page 33](#) and [“01 Exit/Entry 2” on page 33.](#)
- **Silent Exit** Select this check box to silently arm the system without sounding the exit delay beeps. Arming the system in **Stay** mode always uses silent exit.

Figure 20 Arming Screen



## Menu Screen

The **Menu** screen includes the **Arm** and **Toolbox** buttons.

Figure 21 The Menu Screen



If any of the 24-hour emergency options are enabled, an **Emergency** button also appears. It also includes these options:

- **Chime** Select this check box to enable system chimes and clear the check box to disable system chimes. Note that chimes can also be enabled or disabled for each sensor number by tapping **Toolbox** and then **Chimes Setup**.
- **Voice** Select this check box to enable voice announcements for the system. Voice announcements always sound during alarm conditions.

## System Status Screen

The **System Status** screen lists system status and any alerts.

The date and time of alerts are listed in the displayed log.

One option button for Silence is displayed; it temporarily stops the announcement of the system status during the status display.

Figure 22 System Status Screen





## Toolbox and Installer Toolbox

The Control Panel includes two (2) different toolboxes for programming the system:

- **Toolbox.** Individuals with a *user code* can access basic programming functions in the end user Toolbox.
- **Installer Toolbox.** Individuals with the *installer code* can access both the basic programming functions of the user Toolbox and the more advanced programming functions of the Installer Toolbox.

### Toolbox Screens

The Toolbox provides individuals who possess a *user code* with the ability to access basic programming functions.

### Accessing the Toolbox

To access the basic Toolbox screens:

1. At the **Home** screen, tap **Security**, then **Menu**, and then **Toolbox**.
2. At the Enter Your Code to Access the Toolbox screen, enter a *user code*. The default user code is 1111.

Figure 23 Enter Your Code Screen

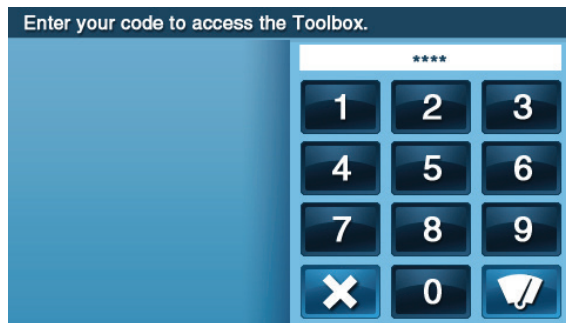

1. When the **Toolbox (1 of 3)** screen appears, tap the left and right arrows to scroll between the different screens.

Each screen provides different buttons for accessing different features.

Figure 24 Toolbox (1 of 3)

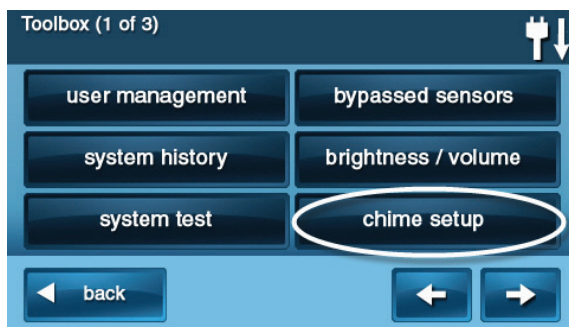
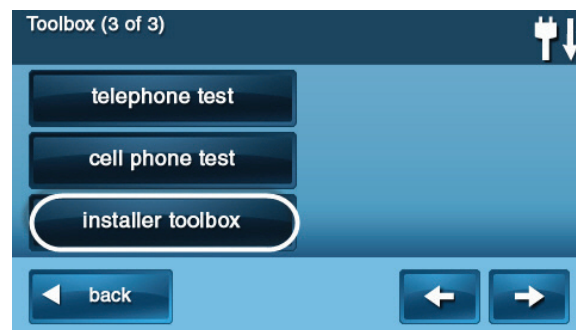

Figure 25 Toolbox (2 of 3)



Figure 26 Toolbox (3 of 3)



### Installer Toolbox Screens

The **Installer Toolbox** screen provides individuals who possess the *installer code* with the ability to access a variety of system configuration and testing buttons.

**NOTE:** The Installer Toolbox is only accessible when the system is disarmed. The *installer code* does NOT disarm the system. You must know the *user code* to disarm the system.

### Accessing the Installer Toolbox

There are two (2) ways to access the Installer Toolbox on the Control Panel:

- At the **Home** screen, tap the system logo in the lower-right corner and then tap the **Installer Toolbox** button. Finally, enter the *installer code*. OR
- At the **Home** screen, tap **Security** > **Menu** > **Toolbox**. Then tap the **Installer Toolbox** button and enter the *installer code*.
- The default installer code is 1561. To learn how to change this code, see Q43: *Installer Code (4 Digits)*.

### Accessing the System Configuration for System and Sensor Programming

To access the system configuration screens for programming sensors into the system:

1. Tap **Disarm** and enter a valid user code. The default user code is 1111.
2. Access the Installer Toolbox. See *Accessing the Installer Toolbox* above.
3. At the **Installer Toolbox** screen, tap the **System Configuration** button.

**NOTE:** The other buttons let you restore the default Control Panel settings and provide access to a variety of system tests.

Figure 27 Installer Toolbox Screen

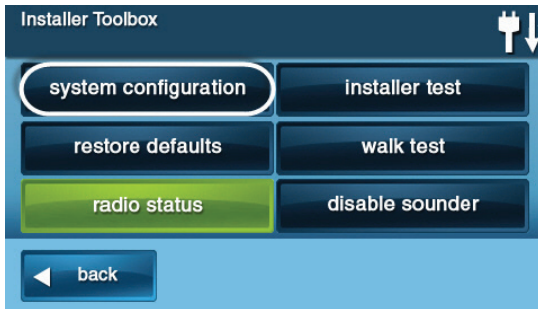

After tapping the **System Configuration** button, the first programming question appears. To learn more, see *System Configuration Screens*.

## System Configuration Screens

Use the System Configuration screens to program sensors into the system. Installers can access the System Configuration screens as described in *Accessing the System Configuration for System and Sensor Programming*.

The System Configuration screens present installers with a sequential list of programming questions. For a list of all available programming questions, see [“Programming Question Table on page 29.”](#)

Figure 28 Q1: Select RF Sensor # (01-48, 63-74).

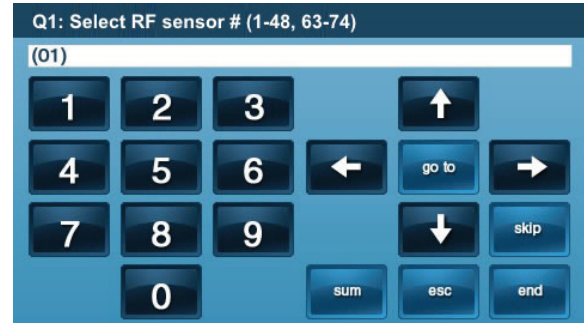

**TIP:** To simplify programming, questions are arranged so that commonly used values appear early in the question sequence.

# System Status Icons

The top line of the Control Panel’s display is the status bar that shows the current system mode, the status of the sensors, and any current system trouble alerts. Special icons are displayed on the right side to provide visual indications of the system’s current condition.

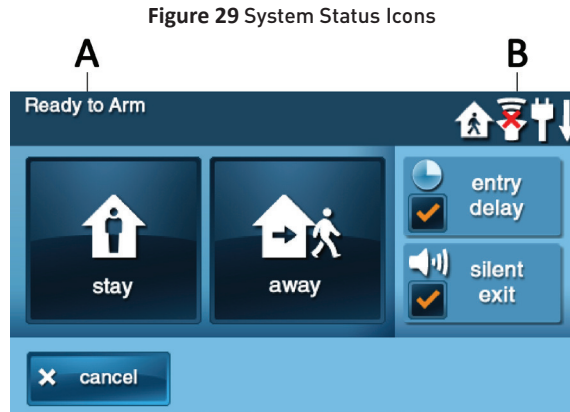

Figure 29 System Status Icons

A Status Bar

B Status Icons

## AC Power On/OFF



**Figure 30 AC Power ON**  
The AC Power icon shows the status of the AC power to the Control Panel. A WHITE plug appears when AC power is present.



**Figure 31 AC Power OFF**  
The AC Power icon shows the status of the AC power to the Control Panel. A RED “X” appears over the WHITE plug when AC power is absent.

## Sounder Disabled



**Figure 32 Sounder Disabled**  
If the system’s internal sounder has been lowered and external sounder has been disabled by the installer for testing, the sounder disabled icon appears. It also flashes to indicate silent arming.

## Low Backup Battery



**Figure 33 Low Backup Battery**  
If the Control Panel’s backup battery tests low, the low backup battery icon appears.

## Test Mode



**Figure 34 Test Mode**  
This icon displays when the system is in Walk Test mode.

## Touch Screen Keypad Traffic



**Figure 35 Touch Screen Keypad Traffic**  
An up arrow indicates the panel is sending information to the touch screen keypad (if installed). A down arrow indicates the touch screen keypad is sending information to panel.

## Cell Radio



**Figure 36 Cell Radio**  
If the option LTE (Cellular) Radio Module is installed, the Cell Radio icon appears while the Control Panel is receiving Over-the-Air (OTA) firmware updates.

## Interior sensor open



**Figure 37 Interior Sensor Open**  
If an interior sensor is open (or a motion detector has just been activated) this icon appears. As a warning, the icon flashes during arming.

## Programming Navigation

When the installer is using the System Configuration menus, the Control Panel will present each programming question sequentially. Most programming questions have a single numeric value response or a simple enabled/ disabled selection. Some programming questions have sub- options that can be set. These sub-options are displayed for the question selected and can be accessed through navigation keys on the display.

### Navigation Arrows & Go To Button

The programming question screens display up, down, left, and right navigation arrows. Use these arrows to scroll through the programming questions and to select sub- options.

Tap the **Go To** button and then enter a two (2)-digit code to jump directly to a programming question. See [“Programming Question Table” on page 28](#). The **Go To** button changes to **Cancel** when waiting for you to enter a question number. Tap **Cancel** to back out.

Figure 38 Navigation Arrows & Go To Button

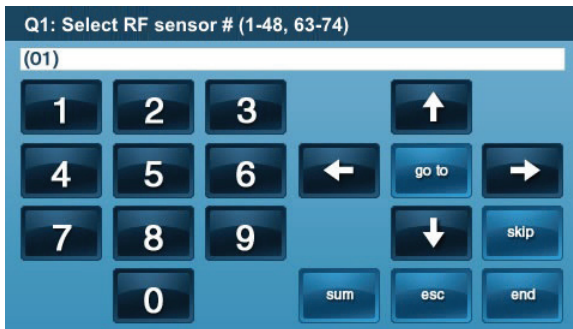

### Questions without Sub-Options

Most of the programming questions do not have sub- options. They navigate as follows. Questions without sub- options do not display a **Skip** button.

Figure 39 Questions without Sub-options



- The ↑ and ↓ arrows select the next or previous programming question.
- The ← and → arrows choose values for the question on or move the cursor left and right along the white data entry field.

### Questions with Sub-Options

Some of the programming questions have sub-options. They navigate as follows. Questions with sub-options display a **Skip** button during the question. The **Skip** button advances to the next programming question/section.

- The ↑ and ↓ arrows select the next or previous programming sub-question.
- The ← and → arrows choose values for the question on or move the cursor left and right along the white data entry field.

Figure 40 Questions with Sub-options



### Questions with Data Entry

Some of the programming questions require entering numeric or alphabetic data. For devices that can be named, the Control Panel contains a large vocabulary with words to choose from. See [“Voice Descriptors” on page 35](#).

- Tap **Insert** to display the first word in the *Voice Descriptors* list. Use the ← and → arrows to scroll through the word list, or enter the corresponding three (3)-digit code. See [“Voice Descriptors” on page 35](#).
- Tap **Backspace** to move the cursor to the left and delete one (1) character at a time.
- Tap **Delete** to delete one character to the right of the cursor or any characters that are highlighted.
- Tap **Forward** to highlight the next word in a multi- word data field.
- Tap **Back** to highlight the previous word in a multi- word data field. The **Back** button displays the previous screen in some cases.
- Tap **Shift** to reveal alternate characters on the keypad that can be used for data entry.

Figure 41 Questions with Data Entry



## Additional Buttons

Depending on the programming question, additional buttons may be displayed on screen:

- Tap **Esc** (Escape) to “undo” the previous action. This is useful when you want to restore the previous value for the question or sub-question.
- Tap **Sum** (Summary) to reveal a summary of the values stored for the question and sub-options.
- Tap **End** to reveal a summary of the values stored for the entire Control Panel memory.
- Tap **Learn** to set the system to receive a sensor’s serial number during programming.
- Tap **Paste** to repeat the last sensor serial number entered.
- Tap **Exit** to exiting the programming module.

Figure 42 Other Buttons Displayed



# Programming Outline

Each system installed will require programming. Most installations being performed by the professional alarm installer for a specific organization will have common values set in every Control Panel that is reporting to the Central Station. Other programming values, such as the account number and sensor setup, may be unique for each installation.

Use the following outline to guide you through the installation process. Understanding the Control Panel's programming structure will help to save time during each installation.

At this stage the following should be already completed:

- All hardwired sensors installed
  - All wireless sensors installed
  - Control Panel mounted, connected, and powered up
1. At the **Home** screen, tap the system logo in the lower right corner.

Figure 43 The Home Screen

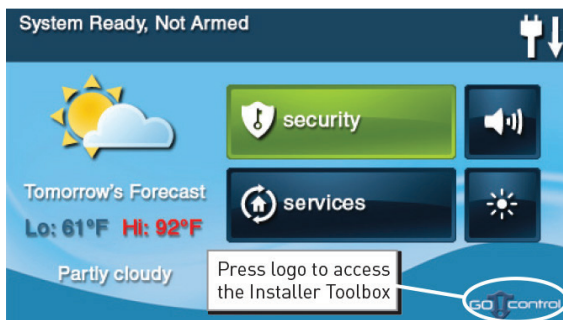

**NOTE:** You can also tap the Installer Toolbox button from the system's **Toolbox (3 of 3)** screen.

2. Enter the *installer code* (the default installer code is 1561) in the **Enter Your Code to Access the Toolbox** screen.
3. At the Installer Toolbox, tap **System Configuration**. Then begin the ["RF Sensor Programming Questions"](#) on page 39.
4. After programming all of the required sensors into the Control Panel, tap **End**, then **Exit**, to save the changes.
5. After the Control Panel restarts, tap **Security > Menu > Toolbox**.
6. When prompted, enter the *master user code*. The default master user code is 1111.
7. Tap the **User Management** button and then setup the user codes. Be sure to set up the Duress Code as User #8. Tap **Back** when finished.
8. Tap **Brightness/Volume** and set the levels for the installation.
9. The volume setting does not affect the volume of alarm sounds.
10. Tap → to view the second toolbox screen.
11. Tap **Back Light Timeout** and set the display lighting timeout.
12. Tap **Set Date and Set Time** and set the calendar and clock. If the LTE (Cellular) Radio Module is installed, the date and time sets automatically.
13. Press the  button to return to the Home screen.

After completing all setup and programming tasks, refer to the Control Panel's *User Guide* for information about operating the system. Check off the programmed options for the system in the *User Guide*.

**NOTE:** Instruct the end user about proper system operations, and leave the *User Guide* at the installation site for reference.

## ANSI/SIA CP-01 Compliance

Several programmable options have the defaults preset to provide compliance with the *American National Standards Institutes/ Security Industry Association CP-01 Control Panel Standard*. The table below details the settings that comply with *ANSI/SIA CP-01* and permanently programmed into the Console. The *ANSI/SIA CP-01* settings documented in the table below cannot be changed:

Programming Questions	ANSI/SIA CP-01 Setting	Range
Q1 > Q: Select RF Sensor# Dialer Delay (0 to 1)	(1) Enabled	(0) Disabled or (1) Enabled
Q2 > Q: Select Wired Sensor Dialer Delay (0 to 1)	(1) Enabled	(0) Disabled or (1) Enabled
Q5 Enter Exit Delay, in Seconds (45-120)	60 Seconds	45-120 Seconds
Q6 Enter Entry Delay 1, in seconds (45-120)	30 Seconds	30-240 Seconds
Q7 Enter Entry Delay 2, in seconds (45-120)	No Default Code	30-240 Seconds
Q10 Enter Call Waiting Disable Code (0-6 digits)	45 Seconds	0-6 Digits
Q20 Select Swinger Shutdown Count (1 to 6)	(2) Two Trips	1-6 Trips
Q26 Select Auto Stay (0 to 1)	(1) Enabled	(0) Disabled or (1) Enabled
Q27 Exit Delay Restart (0 to 1)	(1) Enabled	(0) Disabled or (1) Enabled
Q31 Enter Cancel Time, in Minutes (5-255)	5 Minutes	6-254 Minutes
Q32 Select Cancel Display (0 to 1)	(1) Enabled	(0) Disabled or (1) Enabled
Q35 Select Abort Window Dialer Delay (0 to 2)	30 Seconds	15 to 45 Seconds

## Programming Question Table

Q#	Programming Question/Sub-Question	Default Setting
<b>Q1</b>	<b>Select RF Sensor # (01-48,63-74)</b>	
	Select RF Sensor # Type	(00) Unused
	Select RF Sensor # Equipment Type	Varies by RF sensor type Only shown for some sensor types
	Select RF Sensor # Equipment Code	(0000) Other
	Enter RF Sensor # Other Equipment Code (0-9999)	0 NOTE: Only shown if (0000) Other is selected as the RF Sensor # Equipment Code
	Enter RF Sensor # Serial Number (7 digits)	0000000
	Select RF Sensor # Equipment Age (0 to 1)	(0) New
	Select RF Sensor # Loop Number (1 to 3)	Varies with sensor model selected
	Select RF Sensor # Dialer Delay (0 to 1)	(1) Enabled‡ (2) Disabled (for Fire and CO only)
	Construct RF Sensor # Voice Descriptor	No Default Setting
	Select RF Sensor # Reports (0 to 1)	(1) Enabled
	Select RF Sensor # Supervised (0 to 1)	(1) Enabled
	Select RF Sensor # Chime (0 to 13)	(0) Disabled
<b>Q2</b>	<b>Select Wired Sensor # (1 to 2)</b>	
	Select Wired Sensor # Type	(00) Unused
	Enter Wired Sensor # Equipment Code	
	Select Wired Sensor # Equipment Age (0 to 1)	(0) New
	Select Wired Sensor # Normal State (0 to 3)	(0) Not Used
	Select Wired Sensor # Dialer Delay (0 to 1)	(1) Enabled‡
	Construct Wired Sensor # Voice Descriptor (0 to 1) ‡	No default
	Select Wired Sensor # Reports (0 to 1)	(1) Enabled
	Select Wired Sensor # Chime (0 to 13)	(0) Disabled
<b>Q3</b>	<b>Select Fob # (1 to 8)</b>	
	Select Fob # Used (0 to 1)	(0) Unused
	Select Fob # Equipment Code (0000)	(0000) Other
	Enter Fob # Other Equipment Code (0 to 9999)	0 NOTE: Only shown when (0000) other is selected as the Fob # Equipment Code
	Enter Fob # Serial Number (7 digits)	0000000
	Select Fob # Equipment Age (0 to 1)	(0) New
	Select Fob # Emergency Key (0 to 4)	(0) Disabled
	Select Fob # Key 2 Can Disarm (0 to 1)	(1) Enabled
	Construct Fob # Voice Descriptor	Keyfob #
	Select Fob # Arm No Delay (0 to 1)	(0) Disabled
	Select Fob # Key 4 Output (0 to 2)	(0) Disabled
<b>Q4</b>	<b>Select RF Keypad # (1 to 4)</b>	<b>(0) Unused</b>
	Select RF Keypad # Used (0 to 1)	(0000) Other
	Select RF Keypad # Equipment Code	
	Enter RF Keypad # Other Equipment Code (0 to 9999)	0 NOTE: Only shown if (0000) Other is selected as the RF Keypad # Equipment Code
	Enter RF Keypad # Serial Number (7 digits)	0000000
	Select RF Keypad # Emergency Age (01)	(0) New
	Select RF Keypad # Emergency Keys (01)	(1) Enabled
	Construct RF Keypad # Voice Descriptor	Keypad #
<b>Q5</b>	<b>Enter Exit Delay, in Seconds (45 to 120)</b>	<b>60 seconds‡</b>
<b>Q6</b>	<b>Enter Entry Delay 1, in Seconds (30 to 240)</b>	<b>30 seconds‡</b>
<b>Q7</b>	<b>Enter Entry Delay 2, in Seconds (30 to 240)</b>	<b>45 seconds‡</b>
<b>Q13</b>	<b>Select Two-Way Voice (0 to 2)</b>	<b>(1) Stay Online</b>
<b>Q14</b>	<b>Select Silent Panic/Burglary Listen Only (1 to 1)</b>	<b>(1) Enabled</b>
<b>Q15</b>	<b>Select Dialing Type (0 to 1)</b>	<b>(0) Touch Tone</b>
<b>Q16</b>	<b>Select Police Emergency Key (0 to 2)</b>	<b>(1) Audible</b>
<b>Q17</b>	<b>Select Fire Emergency Key (0 to 1)</b>	<b>(1) Audible</b>
<b>Q18</b>	<b>Select Emergency Key (0 to 1)</b>	<b>(1) Audible</b>
<b>Q19</b>	<b>Select Quick Arming (0 to 1)</b>	<b>(1) Enabled</b>
<b>Q20</b>	<b>Select Swinger Shutdown Count (1 to 6)</b>	<b>(2) Two Trips‡</b>

Q#	Programming Question/Sub-Question	Default Setting
Q21	Select Siren Supervision Time (0 to 3)	(0) Disabled
Q22	Enter CS Lack of Usage Notification Time, in Days (0-255)	7 Days
Q23	Enter Radio Modem Network Failure Time (0-255)	30 Minutes
Q24	Select Radio Modem Network Failure Causes Trouble (0 to 1)	(1) Enabled
Q25	Select Radio Modem Network Failure Reports (0 to 1)	(1) Enabled
Q26	Select Auto Stay (0 to 1)	(1) Enabled ‡
Q27	Select Exit Delay Restart (0 to 1)	(1) Enabled ‡
Q28	Select Quick Exit (0 to 1)	(1) Enabled
Q29	Enter Periodic Test, in Days (0-255)	30 Days
Q31	Enter Cancel Time, in Minutes (5-255)	5 Minutes‡
Q32	Select Cancel Display (0 to 1)	(1) Enabled‡
Q33	Select Cross Sensor 47-48 (0 to 1)	(0) Disabled
Q34	Enter Cross Sensor Timeout, in Seconds (10-120)	10 Seconds
Q35	Select Abort Window Dialer Delay (0 to 2)	(1) 30 Seconds‡
Q36	Select Burglary Bell Cutoff (0 to 4)	(0) 4 Minutes
Q37	Select Fire Bell Cutoff (0 to 4)	(0) 4 Minutes
Q38	Enter Time to Detect AC Loss, in Minutes (1-30)	10 Minutes
Q39	Select Random AC Loss Report Time (0 to 1)	(1) Enabled
Q40	Enter CS #2 Phone Number (0-25 digits)	No Default
Q43	Enter Installer Code (4 digits)	1561
Q44	Select Lock Installer Programming (0 to 2)	(0) Disabled
Q45	Select Lock Default Programming (0 to 2)	(0) Default All
Q46	Select Trouble Doesn't Sound at Night (0 to 1) *	(1) Enabled
Q47	Select Troubles Resound After Holdoff (0 to 7)	(0) Disabled
Q48	Enter Download CSID (6 digits)	000000
Q49	Select Programming Mode Entry Reports to CS (0 to 1)	(0) Disabled
Q50	Select Trouble Reports to CS (0 to 1)	(1) Enabled
Q51	Select Manual Bypass Reports to CS (0 to 1)	(0) Disabled
Q52	Select AC Loss Reports to CS (0 to 1)	(1) Enabled
Q53	Select System Low Battery Reports to CS (0 to 1)	(1) Enabled
Q54	Select RF Low Battery Reports to CS (0 to 1)	(1) Enabled
Q55	Select Opening Reports to CS (0 to 1)	(0) Disabled
Q56	Select Closing Reports to CS (0 to 1)	(0) Disabled
Q57	Select Alarm Restore Reports to CS (0 to 1)	(0) Disabled
Q58	Select Trouble Restore Reports to CS (0 to 1)	(1) Enabled
Q59	Select Bypass Restore Reports to CS (0 to 1)	(0) Disabled
Q60	Select AC Restore Reports to CS (0 to 1)	(1) Enabled
Q61	Select System Low Battery Restore Reports to CS (0 to 1)	(1) Enabled
Q62	Select RF Low Battery Restore Reports to CS (0 to 1)	(1) Enabled
Q63	Select Phone Fail Detect (0 to 1)	(0) Disabled
Q64	Select Smart Test Reports (0 to 1)	(0) Disabled
Q65	Select RF Jam Causes Trouble (0 to 1)	(0) Disabled
Q66	Select Daylight Saving (0 to 1)	(1) Enabled
Q67	Select Daylight Saving Start Month (01 to 12)	(03) March
Q68	Select Daylight Saving Start Sunday (1 to 7)	(2) 2nd
Q69	Select Daylight Saving End Month (01 to 12)	(11) November
Q70	Select Daylight Saving End Sunday (1 to 7)	(1) 1st
Q71	Select System Tamper Causes Trouble (0 to 1)	(1) Enabled
Q72	Select Quick Bypass (0 to 1)	(0) Disabled
Q73	Select Disarming Keyfob After Alarm Alert (0 to 1)	(0) Disabled
Q74	Select Keyfob Arm/Disarm Confirmation (0 to 1)	(0) Disabled
Q75	Select Auto Unbypass for Manual Bypass (0 to 1)	(1) Enabled
Q76	Select Force Bypass Reports (0 to 1)	(0) Disabled
Q77	Select Event Log (0 to 3)	(3) All Events
Q78	Select Output (00-12)	(11) Follows Internal Sounder Alarm‡
Q79	Select Z-Wave Feature (0 to 3)	(3) Enabled with Local Rules
Q80	Select Z-Wave Switches Feature (0 to 1)	(1) Enabled
Q81	Select Z-Wave Thermostats Feature (0 to 1)	(1) Enabled
Q82	Select Z-Wave Door Locks Feature (0 to 1)	(1) Enabled
Q83	Select Temperature Display Units (0 to 1)	(0) Degrees Fahrenheit
	Select date and time format (0 to 2)	(0) MM-DD-YY H:MM AM/PM



Q#	Programming Question/Sub-Question	Default Setting
	Select monetary symbol (0 to 8)	(0) \$
<b>Q84</b>	<b>Select Services Require Master Code</b>	<b>(0) Disabled</b>
<b>Q85</b>	<b>Select Master User Access to Z-Wave Toolbox (0 to 1)</b>	<b>(0) Disabled</b>
<b>Q86</b>	<b>Select Disable Siren After Two-Way Audio (0 to 1)</b>	<b>(0) Disabled</b>
<b>Q87</b>	<b>Select Keyfob/Remote Arming Mode on System Not Ready (0 to 2)</b>	<b>(0) Auto-Bypass with Zone Participation</b>
<b>Q88</b>	<b>Select Z-Wave Siren Mode (0 to 1)</b>	<b>(0) Sound for Burglary and Fire/CO</b>
<b>Q89</b>	<b>Select Allow Backlight Always On (Demo Mode)</b>	<b>(0) Disabled</b>
<b>Q90</b>	<b>Select Energy Feature (0 to 2)</b>	<b>(0) Disabled and Hidden</b>
<b>Q91</b>	<b>Select Radio Modem Supplier</b>	<b>Varies by Supplier**</b>
<b>Q92</b>	<b>Select Network Device (0 to 1)</b>	<b>(0) none</b>
	Network Device ID (Read-Only)	0 <b>NOTE:</b> Only appears if (1) Go!Bridge is selected in Q92 Select Network Device (0 to 1)
	Select Configuration Source (0 to 1)	(0) DHCP
	If (0) DHCP is selected in Select Configuration Source (0 to 1), the following sub-questions appear: Select Port # (1 to 8)	(1) Port 1 <b>NOTE:</b> This option is automatically selected if you choose (0) DHCP in the previous question. Typically, you will skip this question unless additional programming is required.
	Select Used (0 to 1)	(0) Disabled <b>NOTE:</b> Typically, you will skip this question unless additional programming is required.
	Enter Port Value (0-65535)	0 <b>NOTE:</b> Only appears if (1) Enabled is selected in Select Used (0 to 1)
	Enter Port Forward IP Address	000.000.000.000 <b>NOTE:</b> Only appears if (1) Enabled is selected in Select Used (0 to 1). <b>NOTE:</b> Typically, you will accept the default IP address value that appears.
	If (1) Static is selected in Select Configuration Source (0 to 1), the following sub-questions appear	
	Enter Device IP Address	
	Enter Gateway IP Address	
	Enter Subnet Mask	
<b>Q93</b>	<b>Enter Broadband Network Failure Time (1-255)</b>	<b>30</b>
<b>Q94</b>	<b>Select Broadband Network Failure Causes Trouble (0 to 1)</b>	<b>(1) Enabled</b>
<b>Q95</b>	<b>Select Broadband Network Failure Reports (0 to 1)</b>	<b>(1) Enabled</b>
<b>Q96</b>	<b>Select send report 3 times on panel tamper (0 to 1)</b>	<b>(1) Enabled**</b>
<b>Q97</b>	<b>Select sound on normal closing acknowledgment (0 - to - 1)</b>	<b>(1) Enabled**</b>

‡ Indicates the default setting for ANSI/SIA CP-01 compliance

\* To comply with UL 985:Household Fire Warning System Units, the setting for Q46: Select Trouble Doesn't Sound at Night must be set to (0) Disabled.

\*\* To comply with UL 1610: Central-Station Burglar-Alarm Units, Q96and Q97 must beset to (1) enabled. UL 1610 compliance also requires that **Q91: Select Radio Modem Supplier** be set to (1) Radio Modem Supplier 1.

## Zone Numbering

The Control Panel supports 60 wireless protection zones. When programming zones, keep the following numbering ranges in mind:

Zones	Descriptions
1-48	Wireless Zones
47-48	Wireless Cross-Sensor Zone
49-50	Wired Zones
51-58	Keyfobs
59-62	Keypads
63-74	Wireless Zones
92	Duress
95	Fire
96	Medical
99	Police Panic

## Sensor Types (Zones)

Each sensor (wireless or wired) installed in the system is programmed to a specific sensor number and sensor type (zone). The sensor number identifies the specific sensor when it is displayed on the Control Panel, recorded in the event log, or reported to the Central Station. This allows pin-point information about any sensor in the system.

The sensor type determines how and when the Control Panel responds to signals from the sensor. Some sensors are armed all the time, others are armed only in certain arming levels, some cause Central Station Reports anytime they are activated. The sensor's type, along with other programming options, determine this.

Sensor Type (Zone)	Descriptions
<b>(00) Unused</b>	This is the setting for unused sensor numbers that do not have a sensor programmed into them. No system action occurs at any time from this sensor type.
<b>(01) Exit/Entry 1</b>	This sensor type is reserved for doors that are used for exit and entry of the protected premises. When the system is armed in the Stay or Away mode, the exit delay timer starts. There is an exit delay regardless of whether the system is armed in Stay or Away mode. When the exit delay timer expires, the system is fully armed.  With the system fully armed, when this type of sensor is triggered, the Entry Delay 1 timer starts. The system must be disarmed before the Entry Delay 1 timer expires, or an alarm will occur.  If the entry delay timer is turned OFF during arming, the exit/entry delay sensors will act as non-delayed instant sensors at the end of exit delay.
<b>(02) Exit/Entry 2</b>	This sensor type operates the same as the Exit/Entry 1 sensor type except it starts the Entry Delay 2 timer.
<b>(03) Perimeter</b>	This provides a method of having a longer entry delay on certain openings, such as a garage door, to provide the end user more time to disarm the system.  This sensor type is for perimeter doors and windows that will not be used to enter or exit the protected premises while the system is armed. An instant alarm will occur when this type of sensor is triggered with the system armed in either the Stay or Away mode.
<b>(04) Interior Follower</b>	This sensor type is for interior sensors such as motion detector, interior doors, and other sensors that detect human presence inside the protected premises. This type of sensor is called a "follower" due to its action when the system is armed in the Away mode. After the exit delay expires and the system is armed, if an interior follower sensor is triggered, an instant alarm will occur. If an exit/entry delay sensor is triggered first, the interior follower sensor will also be delayed.
<b>(05) Day Zone</b>	Interior follower sensors are always bypassed and not active when the system is armed in Stay mode. This allows the premises to be occupied while still protecting the perimeter.  This sensor type is the same as a perimeter zone, except when the system is disarmed, a violation displays a trouble alert on the Console's display. Common uses for this sensor type are protection of sensitive areas that require notification and possibly a Central Station trouble report, but not an alarm when the system is disarmed.
<b>(06) 24-Hour Silent Alarm</b>	This sensor type is active independent of the system arming status. The code for silent panic is sent to the Central Station, but for safety, there are no visual or audible indications locally that this sensor type has been triggered.
<b>(07) 24-Hour Audible Alarm</b>	This sensor type is continuously armed 24-hours a day. A sensor programmed to this type will trigger a local alarm and the bell output regardless of the mode the system is in. Typical use would be an audible panic alarm.
<b>(08) 24-Hour Auxiliary Alarm</b>	This sensor type is continuously armed 24-hours a day. A sensor programmed to this type will trigger an alarm regardless of the mode the system is in. The bell output will not activate, but the local sounder will continue until it's acknowledged at the Control Panel. Typical use would be for a monitoring device such as a flood or temperature sensor. There is no time out for the internal sounder, it will continue until a user code is entered.
<b>(09) 24-Hour Fire †</b>	This sensor type is continuously armed 24-hours a day. A sensor programmed to this type will trigger the local alarm fire sounder and the bell output regardless of the mode the system is in. Typical use would be for wireless smoke detectors. This sensor type is always active and cannot be bypassed.
<b>(10) Interior with Delay</b>	This sensor type operates as a delayed sensor when the system is armed in the Away mode, and when triggered, will start the Entry Delay 1 timer. If the system is armed in Away mode with no Entry Delay (armed instant), this sensor type will trigger an instant alarm.  If the system is armed in Stay mode (or Stay mode with no Entry Delay), this sensor type will be bypassed.
<b>(14) 24-Hour Carbon Monoxide †</b>	This sensor type is continuously armed 24-hours a day. A sensor programmed to this type will trigger the local alarm pulse sounder and the bell output regardless of the mode the system is in. Typical use would be for wireless carbon monoxide detectors. This sensor type is always active and cannot be bypassed.
<b>(16) 24-Hour Fire with Verification †</b>	This sensor type is continuously armed 24-hours a day. A sensor programmed to this type can trigger the local alarm fire sounder and the bell output regardless of the mode the system is in. Typical use would be for wireless smoke detectors. This sensor type is always active and cannot be bypassed.  For verification, this sensor type must be violated twice in two (2) minutes, or remain violated for 30 seconds. If any other fire sensor (verified sensor type or not) violates within two minutes, both sensors will cause a fire alarm.  <b>WARNING</b> THIS UNIT INCLUDES AN ALARM VERIFICATION FEATURE THAT WILL RESULT IN A DELAY OF THE SYSTEM ALARM SIGNAL FROM THE INDICATED CIRCUITS. THE TOTAL DELAY (CONTROL UNIT PLUS SMOKE DETECTORS) SHALL NOT EXCEED 60 SECONDS. NO OTHER SMOKE DETECTOR SHALL BE CONNECTED TO THESE CIRCUITS.

Sensor Type (Zone)	Description
<b>(23) No Response Type</b>	This sensor type is a special zone that can be monitored for activity or inactivity by the Central Station. It does not affect security system status.
<b>(24) Silent Burglary</b>	This sensor type is for silent triggering the burglary alarm with perimeter doors and windows that will not be used to enter or exit the protected premises while the system is armed. The Control Panel's sounder and the bell output will not activate. An instant silent alarm will occur when this type of sensor is triggered with the system armed in either the Stay or Away mode.
<b>(32) Remote Device*</b>	This zone type is selected by the installer when pairing the panel with peripheral devices that can utilize localized troubles (such as RF jam, low battery, tamper, or AC loss detected by the peripheral device). This sensor is continuously active and will cause a trouble at the panel for all problem conditions. When the panel is in an armed state, this sensor type will cause an alarm for TAMPER and RF JAM. All trouble conditions will be sent to the monitoring station if reporting is enabled with the exception of AC LOSS. This will only be displayed at the panel.

† Indicates Sensor types that are not allowed for hardwired loops.

\* Sensor Type Reporting is only supported on [Alarm.com](http://Alarm.com).

## Voice Descriptors

The Control Panel includes a system vocabulary. When programming sensors when using firmware version 1.13, you can use the codes detailed in this table:

**Figure 44** List of Voice Descriptors

Code	Description	Code	Description	Code	Description	Code	Description
002	ABORT	041	CLOSET	080	FIFTEEN	119	INTRUSION
003	AC	042	CODE	081	FIFTY	120	IS
004	ACCESS	043	COMMUNICATIONS	082	FIRE	121	KEY
005	ALARM	044	COMPUTER	083	FIRE ALERT	122	KEYFOB
006	AND	045	CONTROL	084	FIRE DETECTOR	123	KEYPAD
007	ANNOUNCEMENT	046	COOL	085	FIRST	124	KIDS
008	AREA	047	CRAWL	086	FIVE	125	KITCHEN
009	ARM	048	CURRENT	087	FLOOD	126	LAUNDRY
010	ARMED	049	DAY	088	FLOOR	127	LEFT
011	ARMING	050	DEGREES	089	FLUID	128	LEVEL
012	AT	051	DEN	090	FOIL	129	LIBRARY
013	ATTIC	052	DETECTOR	091	FOR	130	LIGHT
014	AUDIO	053	DIM	092	FORTY	131	LIGHTS
015	AUTO	054	DINING	093	FOUR	132	LIQUOR
016	AUTOMATION	055	DISARM	094	FOURTEEN	133	LIVING
017	AUXILIARY	056	DISARMED	095	FOURTH	134	LOADING
018	AWAY	057	DOCK	096	FREEZE	135	LOCK
019	BABY'S	058	DOOR	097	FREEZER	136	LOFT
020	BACK	059	DOWNSTAIRS	098	FRONT	137	LOW
021	BASEMENT	060	DRIVEWAY	099	FURNACE	138	MAIN
022	BATHROOM	061	EAST	100	GAME	139	MAINTENANCE
023	BATTERY	062	EIGHT	101	GARBAGE	140	MASTER
024	BEDROOM	063	EIGHTEEN	102	GAS	141	MEDICAL
025	BONUS	064	EIGHTY	103	GLASS	142	MEDICINE
026	BREAK	065	ELECTRIC	104	GLASS BREAK	143	MENU
027	BUTTON	066	ELEVEN	105	GUEST	144	MIDDLE
028	BYPASS	067	EMERGENCY	106	GUN	145	MONITOR
029	BYPASSED	068	ENTER	107	HALL	146	MOTION
030	CABINET	069	ENTRANCE	108	HALLWAY	147	MOTION DETECTOR
031	CANCEL	070	ENTRY	109	HANGING	148	MUD
032	CARBON MONOXIDE	071	ERROR	110	HANGUP	149	NINE
033	CELLAR	072	EXERCISE	111	HEAT	150	NINETEEN
034	CELLULAR	073	EXIT	112	HIGH	151	NINETY
035	CELL RADIO	074	EXIT NOW	113	HOME	152	NORTH
036	CENTER	075	EXTERIOR	114	HOUSE	153	NOT
037	CHECK	076	EXTERNAL	115	ICE	154	NOT READY
038	CHEST	077	FAILURE	116	INSIDE	155	NO DELAY
039	CHILDREN'S	078	FAMILY	117	INSTANT	156	NO ENTRY DELAY
040	CHIME	079	FAN	118	INTERIOR	157	NURSERY

Code	Description	Code	Description
158	OFF	197	SEVENTY
159	OFFICE	198	SHED
160	ON	199	SHOP
161	ONE	200	SIDE
162	ONE HUNDRED	201	SILENT
163	OUTPUT	202	SIREN
164	OUTSIDE	203	SIX
165	PANEL	204	SIXTEEN
166	PANIC	205	SIXTY
167	PANTRY	206	SKYLIGHT
168	PATIO	207	SLIDING
169	PERIMETER	208	SMOKE
170	PHONE LINE	209	SOUNDER
171	PLAY	210	SOUTH
172	POLICE	212	SPARE
173	POOL	213	STAIRS
174	POUND	214	STAR
175	POWER	215	STATUS
176	PRESS	216	STAY
177	PREVIOUS	217	STOP
178	PUMP	218	STORAGE
179	RADIO	219	STUDY
180	READY	220	SUMP
181	REAR	221	SUPERVISION
182	RELAY	222	SYSTEM
183	REMOTE	223	TAMPER
184	REPEAT	224	TEMPERATURE
185	RF JAM	225	TEN
186	RIGHT	226	TERMINATED
187	ROOM	227	THERMOSTAT
188	SAFE	228	THIRD
189	SECOND	229	THIRTEEN
190	SECURITY	230	THIRTY
191	SENSOR	231	THREE
192	SENSORS	232	TO
193	SESSION	233	TOOL
194	SET	234	TRANSMITTED
195	SEVEN	235	TRANSMITTER
196	SEVENTEEN	236	TROUBLE

Code	Description	Code	Description
237	TURN	276	DAUGHTER'S
238	TWELVE	277	DOORBELL
239	TWENTY	278	GIRL'S
240	TWO	279	IMAGE
241	UNLOCK	280	IMAGE SENSOR
242	UPPER	281	MAIN
243	UPSTAIRS	282	SON'S
244	USER	283	SUN
245	UTILITY	284	THEATER
246	VALVE	285	WING
247	VOICE	286	SWITCH
248	WALL		
249	WATER		
250	WEST		
251	WINDOW		
252	WIRELESS		
253	YARD		
254	ZERO		
255	ZONE		
256	BALCONY		
257	COURTYARD		
258	DECK		
259	DETACHED		
260	OVERHEAD		
261	REFRIGERATOR		
262	SERVICE		
263	WAREHOUSE		
264	GATE		
265	APARTMENT		
266	FOYER		
267	TV		
268	VIDEO		
269	PORCH		
270	CORNER		
271	BELL		
272	BOY'S		
273	CAMERA		
274	CAVE		
275	DAUGHTERS		

## Equipment Codes

The table below details the available equipment codes:

Code	Description
[0000]	Other
[0470]	HW R-D/W "5818MNL"
[0475]	Existing Glass Break Detector
[0491]	HW Panic Pendant "5802MN2"
[0519]	HW Glass Break "5853"
[0530]	HW PIR "5894PI"
[0533]	HW PIR "5890"
[0556]	Existing Flood/Temp Sensor
[0557]	HW Heat Sensor "5809"
[0577]	Existing Keyfob Remote
[0589]	HW Smoke "5808W3"
[0609]	Existing Motion Detector
[0616]	Existing Smoke Detector
[0624]	HW Flood Sensor "5821"
[0637]	HWD/W"5816"
[0655]	Existing Door/Window Contact
[0692]	Existing CO Detector
[0708]	Existing Heat Sensor
[0859]	CO1-345C CO Detector (Canada)
[0860]	CO1-345 CO Detector (USA)
[0862]	2GIG Thin Door/Window Contact
[0863]	2GIG Recessed Door Contact
[0864]	2GIG Glass Break Detector
[0866]	2GIG 4-Button Keyfob Remote
[0867]	2GIG Wireless Keypad
[0868]	2GIG Panic Button Remote
[0869]	2GIG PIR with Pet Immunity
[0871]	SMKE1-345C Smoke Detector (Canada)
[0872]	SMKE1-345 Smoke Detector (USA)
[0873]	2GIG Takeover Module
[0895]	SMTK2-345 GE Smoke/Heat Detector (USA/Canada)
[1026]	2GIG CO Detector
[1058]	2GIG Smoke Detector
[1059]	2GIG-TS1 Wireless Touchscreen Keypad
[1061]	Tilt Sensor
[1062]	2GIG Tilt Sensor
[1063]	2GIG Doorbell
[1064]	2GIG Bypass Sensor
[1065]	2GIG Flood Sensor
[1067]	2GIG Repeater
[1068]	2GIG Translator
[9999]	Alarm.com Image Sensor

# Installer Programming

## Account Registration

Register the account to enroll the Control Panel with the remote service provider's Central Station.

Typically, the account registration data is created with the service installation contract and then stored in a database managed by the Central Station. The data includes items such as the customer name, address, and the Central Station telephone number, and the account number assigned to the Control Panel.

If you will be installing the 2GIG Go!Bridge IP Communicator, additional registration information is required. For details, see the *Installation Instructions* included with the Go!Bridge IP Communicator.

## Wireless (RF) Sensor Programming

The Control Panel can be programmed with up to 60 RF sensors of different types. In addition to the 60 multi-purpose RF sensors, you can also program eight (8) RF remote control key fobs and four (4) RF remote control keypads into the system.

**RF sensors # 01-48 and #63-74 report as wireless zones 01- 60.**

Programming questions for RF sensor programming include:

- **Q1: Select RF Sensor Number.** Select sensor number 01-48 or 63-74.
- **Q: Select RF Sensor # Type.** Select (01) *Exit/Entry 1*, (02) *Exit/Entry 2*, (03) *Perimeter*, and so on. For options, see ["Zone Numbering" on page 32](#).
- **Q: Select RF Sensor # Equipment Type.** Some sensor types ask for the equipment type, others do not. See ["Q: Select RF Sensor # Equipment Type" on page 40](#).
- **Q: Select RF Sensor # Equipment Code.** Select the four (4)-digit equipment code for the sensor model. See ["Equipment Codes" on page 37](#).
- **Q: Enter RF Sensor # Other Equipment Code.** If you select (0000) *Other* in the previous question, you must enter this code.
- **Q: Enter RF Sensor # Serial #.** Enter the serial number (typically a label on the sensor or its packaging) or tap **Shift** then **Learn** on the panel. Then trip the sensor to transmit the serial number to the panel.
- **Q: Select RF Sensor # Equipment Age.** Specify whether the sensor is (0) *New* or (1) *Existing*.
- **Q: Select RF Sensor # Loop Number.** Specify the appropriate loop number(s) for the sensor. See ["Q: Select RF Sensor # Loop Number \(1 to 3\)" on page 40](#).
- **Q: Select RF Sensor # Dialer Delay.** Specify whether to use delayed or instant digital communicator reports for the sensor. The delay time is set on the Dialer Abort screen.
- **Q: Construct RF Sensor # Voice Descriptor.** Specify the name assigned to the sensor that is announced if this feature is programmed.
- **Q: Select RF Sensor # Reports.** Specify (0) *Disabled* or (1) *Enabled* whether or not RF sensors trigger a report to the Central Station.
- **Q: Select RF Sensor # Supervised.** Specify whether or not the Control Panel checks for status reports from the sensor.
- **Q: RF Sensor # Chime.** Select voice announcement and chime options for the sensor.



## Q1: RF Sensor Programming Outline

Figure 45 RF Sensor Programming Outline

### Q1: RF Sensor Programming Outline

**Q1: SELECT RF SENSOR #**  
ENTER ON KEYPAD OR PRESS [←] OR [→] TO SELECT FROM LIST  
PRESS [↓] FOR NEXT OPTION

**Q: SELECT RF SENSOR # TYPE**  
ENTER ON KEYPAD OR PRESS [←] OR [→] TO SELECT FROM LIST  
PRESS [↓] FOR NEXT OPTION

**Q: SELECT RF SENSOR # EQUIPMENT TYPE**  
ENTER ON KEYPAD OR PRESS [←] OR [→] TO SELECT FROM LIST  
PRESS [↓] FOR NEXT OPTION

**Q: SELECT RF SENSOR # EQUIPMENT TYPE**  
ENTER ON KEYPAD  
PRESS [↓] FOR NEXT OPTION

**Q: ENTER RF SENSOR OTHER EQUIPMENT CODE**  
(Only appears if (0000) Other was selected in previous question)  
ENTER ON KEYPAD OR PRESS [←] OR [→] TO SELECT FROM LIST  
PRESS [↓] FOR NEXT OPTION

**Q: SELECT RF SENSOR SERIAL NUMBER**  
ENTER ON KEYPAD OR PRESS [shift] OR [learn] THEN TRIP SENSOR TO SEND SIGNAL  
PRESS [↓] FOR NEXT OPTION

**Q: SELECT RF SENSOR EQUIPMENT AGE**  
ENTER ON KEYPAD OR PRESS [←] OR [→] TO SELECT FROM LIST  
PRESS [↓] FOR NEXT OPTION

**Q: SELECT RF SENSOR LOOP NUMBER**  
ENTER ON KEYPAD OR PRESS [←] OR [→] TO SELECT FROM LIST  
PRESS [↓] FOR NEXT OPTION

**Q: SELECT RF SENSOR DIALER DELAY**  
ENTER ON KEYPAD OR PRESS [←] OR [→] TO SELECT FROM LIST  
PRESS [↓] FOR NEXT OPTION

**Q: CONSTRUCT RF SENSOR VOICE DESCRIPTOR**  
PRESS [shift] FOR EACH WORD  
ENTER ON KEYPAD OR PRESS [←] OR [→] TO SELECT FROM LIST  
PRESS [↓] FOR NEXT OPTION

**Q: SELECT RF SENSOR REPORTS**  
ENTER ON KEYPAD OR PRESS [←] OR [→] TO SELECT FROM LIST  
PRESS [↓] FOR NEXT OPTION

**Q: SELECT RF SENSOR SUPERVISED**  
ENTER ON KEYPAD OR PRESS [←] OR [→] TO SELECT FROM LIST  
PRESS [↓] FOR NEXT OPTION

**Q: SELECT RF SENSOR CHIME**  
ENTER ON KEYPAD OR PRESS [←] OR [→] TO SELECT FROM LIST  
PRESS [↓] TO FINISH PROGRAMMING SENSOR  
THEN PRESS [edit next] TO PROGRAM THE NEXT SENSOR  
OR PRESS [skip] TO JUMP TO Q2: WIRED SENSOR PROGRAMMING

Scroll between options using the ← and → arrows. Move to the previous or next prompt by tapping the ↑ and ↓ arrows.

1. To program another sensor tap Next.
2. To exit programming, tap Skip then End and Exit. Upon exit, the panel takes several seconds to restart. \*Only used for "other" equipment

\*\*Tap **Insert** for each word. To select from the list, you can use the keypad or tap the ← or → arrows.

## Summary of RF Sensor # Screen

After setting all the options for a sensor, the RF sensor summary screen is displayed. The screen can also be displayed for programmed sensors during RF sensor program editing by tapping the **Sum** button.

- While programming each RF sensor remember that the ← and → arrow buttons step through each of the RF sensor numbers.
- To return to programming, tap **Edit Current** or **Edit Next**.
- Tap **Skip** to go to question number Q2 (Wired Sensor Programming). See "[Wired Sensor Programming](#)" on page 41.

Figure 46 Summary of RF Sensor # Screen

## RF Sensor Programming Questions

### Q1: Select RF Sensor # (01-48, 63-74)

Up to 60 wireless RF sensors can be used with each Control Panel. The options for each sensor are programmed with sub-option questions.

1. Enter the RF sensor number or tap the ← or → arrows to select it.
2. Program the sensor details by using the ↑ and ↓ arrows to select each of the sub-options.

**NOTE:** To skip Q1 and jump directly to Q2 for Wired Sensor Programming, tap **Skip**.

### Q: Select RF Sensor # Type

**DEFAULT: (00) Unused**

Answer this question to define the sensor type (zone). Simply enter the appropriate code (see table below) or tap the ← or → arrows to select the desired zone.

In the table below, a "Y" indicates the sensor type can be assigned. A "N" indicates the sensor type is not used, and an asterisk (\*) denotes that selecting this sensor type also requires you to answer the *Q: Select RF Sensor # Equipment Type* question.

Sensor Types (Zone)	RF	Wired
(00) Unused	Y	Y
(01) Exit/Entry 1	Y	Y
(02) Exit/Entry 2	Y	Y
(03) Perimeter	Y	Y
(04) Interior Follower*	Y	Y
(05) Day Zone	Y	Y
(06) 24-Hour Silent Alarm*	Y	Y
(07) 24-Hour Audible Alarm*	Y	Y

Sensor Types (Zone)	RF	Wired
(08) 24-Hour Auxiliary Alarm*	Y	Y
(09) 24-Hour Fire	Y	N
(10) Interior with Delay*	Y	Y
(14) 24-Hour Carbon Monoxide	Y	N
(16) 24-Hour Fire Verification	Y	N
(23) No Response Type*	Y	Y
(24) Silent Burglary	Y	Y

## Q: Select RF Sensor # Equipment Type

**DEFAULT: Varies by RF Sensor Type**

**NOTE:** Some sensor types (zones) will require you to specify an equipment type selection, which affects the sensor's extended reporting code.

Simply enter the appropriate equipment type code (see table below) or tap the ← or → arrows to select the appropriate equipment type.

The table below shows the Equipment Types available for each Sensor Type (Zone):

Sensor Type (Zone)	Equipment Types
(04) Interior Follower	(1) Motion (2) Contact
(06) 24-Hour Silent Alarm	(1) Contact (11) Emergency
(07) 24-hour Audible Alarm	(1) Contact (11) Emergency
(08) 24-Hour Auxiliary	(1) Contact (6) Freeze (8) Water (10) Temperature (11) Emergency
(10) Interior with Delay	(1) Motion (2) Contact
(23) No Response Type	(1) Contact (2) Motion

## Q: Select RF Sensor # Equipment Code

**DEFAULT: (0000) Other**

Select the four (4)-digit equipment code that corresponds to the appropriate sensor model. See ["Equipment Codes" on page 37](#).

## Q: Select RF Sensor # Other Equipment Code

**NOTE:** This sub-question is only displayed if (0000) Other is selected as the **RF Sensor # Equipment Code**.

Enter the equipment code number directly on the keypad for the RF sensor. Enter "0" if the new equipment code is unknown.

## Q: Enter RF Sensor # Serial Number (7 Digits)

**DEFAULT: 0000000**

RF sensor serial numbers can be manually entered or automatically transmitted from the sensor to the Control Panel.

- **For manual entry.** Enter the sensor number that was logged for the sensor being programmed. Tap **Shift** to access alphabetic characters.

- **For automatic entry.** Tap **Shift**, then tap **Learn** to place the Control Panel into learning mode. Then trigger the RF sensor. The Control Panel will beep four (4) times and learn the sensor's serial number. If the sensor being learned is already in memory, the Control Panel will display a sensor learning failure screen when the programming changes are being saved.

For certain sensors with more than two loops, the tamper switch must be used to send a signal to the Control Panel during sensor learning. The first press of the tamper switch will learn the sensor into the panel as Loop #1. The second press of the tamper switch will learn the sensor into the panel as Loop #2, and the third press of the tamper switch will learn the sensor into the panel as Loop #3. Pause 15 seconds between each press of the tamper switch.

The programmed loop number of the sensor in the Control Panel may need changing to suit the operation of the device. For details, see the *Installation Instructions* included with the sensor.

## Q: Select RF Sensor # Equipment Age (0 to 1)

**DEFAULT: (0) New**

The Control Panel can be used with new or existing RF sensors.

- If this RF sensor is new for the installation, leave the default setting of (0) New.
- If this RF sensor is already installed, select (1) Existing.

**NOTE:** If the RF sensor has more than one loop and is being programmed into multiple sensor numbers to support the loops, set only one loop as "new" and the other loops as "existing". This will prevent incorrect inventory of the installed sensors.

## Q: Select RF Sensor # Loop Number (1 to 3)

**DEFAULT: Varies with sensor model selected**

The 2GIG Door/Window Contact sensors have two (2) inputs: an internal magnetic contact and an external *Normally Closed* (N/C) hardwired input. Either or both sensor inputs can be used.

**TIP:** Some sensors are capable of three (3) loop inputs.

**NOTE:** When using both the internal magnetic contact and the external input, the magnet contact AND the external contact must be assigned a different RF sensor number. Both sensor numbers will share the same sensor serial number.

- When programming the sensor to use the built-in magnetic contact, set the loop number to (2) 2.
- When programming the sensor to use its hardwired input, set the loop number as (1) 1.
- When programming a three (3)-loop sensor to use an additional input, set the loop number as (3) 3.
- When entering the sensor number for the sensor's loop 2 or 3, tap **Paste** to recall the last programmed sensor's serial number. (The sensor number will be filled in automatically if **Learn** is used).

## Q: Select RF Sensor # Dialer Delay (0 to 1)

**DEFAULT: (1) Enabled**

If this feature is enabled, the delay time must be set to a minimum of 30 seconds for ANSI/SIA compliance. To set the delay time, see ["Q35: Abort Window Dialer Delay \(0-2\)" on page 52](#).

- RF sensors can trigger the digital communicator immediately or after a delay. The default setting (1) Enabled causes delayed dialing for this RF sensor number.
- For immediate dialing for this RF sensor number, select (0) Disabled.

**NOTE:** This setting for CO and Smoke Alarms is automatically set to (0) Disabled, and this sub-question is skipped for these sensor types.

## Q: Construct RF Sensor # Voice Descriptor

### DEFAULT: No Default

**NOTE:** For a list of available voice descriptors, see [“Voice Descriptors” on page 35](#).

The voice descriptors are the words the Control Panel will announce for this RF sensor if this sensor is programmed for voice annunciation. Up to five(5) words are allowed.

1. Tap **Insert** to place a word from the vocabulary into the data entry field.
2. Tap the ← or → arrows to scroll through the words, or enter the word's three (3)-digit index number.
3. Tap **Insert** again for the next word. Up to five words are allowed.
4. To move between words, tap the **Fwd** and **Back** buttons.
5. To remove a word, tap Delete.

## Q: Select RF Sensor # Reports (0 to 1)

### DEFAULT: (1) Enabled

RF sensors can be programmed to trigger a report to the Central Station or not.

- The default setting (1) *Enabled* enables reporting for this RF sensor number.
- To prevent reporting for this RF sensor number, select (0) *Disabled*.

## Q: Select RF Sensor # Supervised (0 to 1)

### DEFAULT: (1) Enabled

When a sensor is set to supervised, the Control Panel will expect regular timed signals from this sensor or else a sensor supervisory trouble alert will occur.

- The default setting (1) *Enabled* allows supervision for this RF sensor.
- To turn off supervision for this RF sensor, select (0) *Disabled*.

**NOTE:** Portable sensors such as panic buttons should not be set as supervised if the sensor will be removed from the premises at times.

## Q: Select RF Sensor# Chime (00 to 13)

### DEFAULT: (0) Disabled

Each RF sensor can be set to sound a “ding-dong” chime and/or sound its voice descriptor when the sensor is triggered. This step determines the initial setting for the sensor.

The end user can change the chime setting for sensors using **Chime Setup** in the User Toolbox.

- The default setting (0) *Disabled* disables the chime for this RF sensor.
- If a chime and/or voice is required for this RF sensor, choose one of the other chime options:

Code	Sensor Chime
(0)	Disabled
(1)	Voice Only
(2)	Ding-Dong with Voice #1
(3)	Ding-Dong #2
(4)	Ding-Dong with Voice #2
(5)	Ding-Dong #1
(6)	Ding-Ding
(7)	Ding-Ding with Voice
(8)	Ding-Dong #3
(9)	Ding-Dong with Voice #3
(10)	Chime #1
(11)	Chime #1 with Voice #1
(12)	Chime #2
(13)	Chime #2 with Voice #2

## Wired Sensor Programming

The Control Panel can be programmed with up to two (2) wired sensors. The wired sensors are hardwired contact loops connected to the loop input terminals on the Control Panel's terminal strip. To see where the two (2) hardwired sensors can be wired into the Terminal Block, see the [“Terminal Block Wiring Diagram” on page 17](#).

**CAUTION:** Wired sensors cannot be used for a CO or Fire sensor loop.

**IMPORTANT:** Note that Wired Sensor reports as below:

- Wired Sensor #1 = Reports as Sensor #49

See *Figure 47 Wired Sensor Programming Outline* on the next page for the steps required to program wired sensors into the Control Panel. The options that can be set for each wired sensor are:

- **Q2: Wired Sensor Number.** Select 1 or 2.
- **Q: Wired Sensor # Type.** Select the zone. For example, (01) *Exit/Entry 1*, (02) *Exit/Entry 2*, (03) *Perimeter*, and so on. See [“Zone Numbering” on page 32](#).
- **Q: Wired Sensor # Equipment Type.** Some sensor types (zones) will prompt you to specify the equipment type. Other sensor types will not prompt you for an equipment type.
- **Q: Wired Sensor # Equipment Code.** Select the four (4)-digit equipment code that corresponds to the appropriate sensor model. See [“Equipment Codes” on page 37](#).
- **Q: Wired Sensor # Equipment Age.** Specify whether the sensor is a (0) *New* or (1) *Existing* sensor.
- **Q: Wired Sensor # Normal State.** Choose between (0) *Not Used*, (1) *Closed*, (2) *Open*, (3) *End-Of-Line-Resistor*.
- **Q: Wired Sensor # Dialer Delay.** Specify whether to use delayed or instant digital communicator reports for the sensor. The delay time is set on the Dialer Abort screen.
- **Q: Wired Sensor # Voice Descriptor.** Specify the name assigned to the sensor that is announced if this feature is programmed.
- **Q: Wired Sensor # Reports.** Specify whether or not to send digital communicator reports for the sensor.

## Q2: Wired Sensor Programming Outline

Figure 47 Wired Sensor Programming Outline

### Q2: Wired Sensor Programming Outline

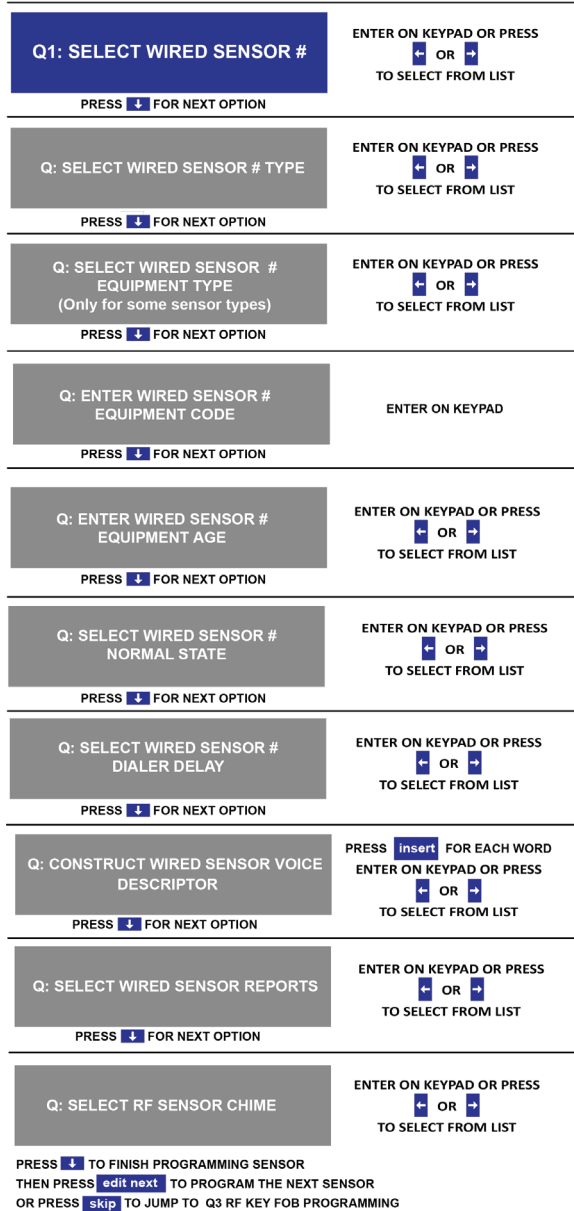

Scroll between options using the ← and → arrows. Move to the previous or next prompt by tapping the ↑ and ↓ arrows.

- To program another sensor tap **Next**.
- To exit programming, tap **Skip** then **End** and **Exit**. Upon exit, the panel takes several seconds to restart

## Summary of Wired Sensor # Screen

After setting all the options for a sensor, the wired sensor summary screen is displayed. The screen can also be displayed for programmed sensors during wired sensor program editing by tapping the **Sum** button.

- While programming each wired sensor remember that the ← and → arrow buttons step through each of the wired sensor numbers.
- To return to programming, tap **Edit Current** or **Edit Next**.
- Tap **Skip** to go to question number Q3 (RF Key Fob Programming). See [“Wireless \(RF\) Key Fob Programming” on page 44](#).

Figure 48 Summary of Wired Sensor # Screen



**NOTE:** For the detailed steps of programming a wired sensor, see [“Wired Sensor Programming Questions” on page 41](#).

## Wired Sensor Programming Questions

### Q2: Select Wired Sensor # (1-2)

Two hardwired loops can be used as sensors with each Control Panel. The options for each wired sensor are programmed with sub-option questions.

- Begin by entering the wired sensor number or select it using the ← or → arrows.
- After selecting the wired sensor number, program the wired sensor details by using the ↑ and ↓ arrows to select each of the sub-options.

**NOTE:** To skip wired sensor programming, tap **Skip** to jump from question Q2 to question Q3. See [“Wireless \(RF\) Key Fob Programming” on page 44](#).

### Q: Select Wired Sensor# Type

**DEFAULT: (00) Unused**

Each wired sensor needs to be assigned to a sensor type. Select the sensor type that matches the wired sensor’s function using the ← or → arrows or enter the sensor type number directly on the keypad.

In the table below, a “YES” indicates the sensor type can be used for the wired sensor. An “NO” indicates the sensor type is not used.

Sensor Types (Zone)	RF Sensors	Wired Sensors
(00) Unused	Yes	Yes
(01) Exit/Entry 1	Yes	Yes
(02) Exit/Entry 2	Yes	Yes
(03) Perimeter	Yes	Yes

Sensor Types (Zone)	RF Sensors	Wired Sensors
(04) Interior Follower	Yes	Yes
(05) Day Zone	Yes	Yes
(06) 24-Hour Silent Alarm	Yes	Yes
(07) 24-Hour Audible Alarm	Yes	Yes
(08) 24-Hour Auxiliary Alarm	Yes	Yes
(09) 24-Hour Fire	Yes	No
(10) Interior with Delay	Yes	Yes
(14) 24-Hour Carbon Monoxide	Yes	No

## Q: Select Wired Sensor# Equipment Type

**DEFAULT: Varies by wired sensor type**

**NOTE:** This question is only displayed when certain sensor types (zones) are selected.

The equipment type selection will affect the sensor's extended reporting code.

The following sensor types require equipment type selection:

Sensor Type (Zone)	Equipment Types
(04) Interior Follower	(1) Motion (2) Contact
(06) 24-Hour Silent Alarm	(1) Contact (11) Emergency
(07) 24-hour Audible Alarm	(1) Contact (11) Emergency
(08) 24-Hour Auxiliary	(1) Contact (6) Freeze (8) Water (10) Temperature (11) Emergency
(10) Interior with Delay	(1) Motion (2) Contact
(23) No Response Type	(1) Contact (2) Motion

Select the equipment type that matches the sensor equipment using the ← or → arrows, or enter the equipment type number directly on the keypad.

**NOTE:** This Control Panel does not provide auxiliary accessory output power.

Connecting a hardwire PIR using equipment type "motion" will require an external stand-alone battery backed-up power supply for the PIR.

## Q: Wired Sensor # Equipment Code (0-9999)

**DEFAULT: (0)**

Select the four (4)-digit equipment code that corresponds to the appropriate sensor model. See ["Equipment Codes" on page 37](#).

## Q: Select Wired Sensor# Equipment Age (0 to 1)

**DEFAULT: (0) New**

The Control Panel can be used with new or existing wired sensors.

- If this wired sensor is new for the installation, leave the default setting of (0) *New*.
- If this wired sensor is already installed, select (1) *Existing*.

## Q: Select Wired Sensor# Normal State

**DEFAULT: (0) Not Used**

The two hardwired loops can be wired for normally open (N/O) or normally closed (N/C) contacts, or for end-of-line (EOL) resistor.

- The default setting (0) *Not Used* disables this wired sensor.
- To use this wired sensor, select the way the loop is wired:

**Wired Sensor Normal State**

- (0) *Not Used*
- (1) *Closed*
- (2) *Open*
- (3) *End-of-Line Resistor*

## Q: Select Wired Sensor# Dialer Delay (0 to 1)

**DEFAULT: (1) Enabled**

If this feature is enabled, the delay time must be set to a minimum of 30 seconds for ANSI/SIA compliance. To set the delay time, see ["Q35: Abort Window Dialer Delay \(0-2\)" on page 52](#).

Wired sensors can trigger the digital communicator immediately or after a delay.

- The default setting (1) *Enabled* causes delayed dialing for this wired sensor number.
- For immediate dialing for this wired sensor number, select (0) *Disabled*.

## Q: Construct Wired Sensor # Voice Descriptor

**DEFAULT: No Default**

**NOTE:** For a list of voice descriptors, see ["Voice Descriptors" on page 35](#).

The voice descriptors are the words the Control Panel will announce for this wired sensor if this wired sensor is programmed for voice annunciation. Up to five (5) words are allowed.

1. Tap **Insert** to place a word from the vocabulary into the data entry field.
2. Use the ← or → arrows to scroll through the words, or enter the word's three (3)-digit number.
3. Tap **Insert** again for the next word. Up to five (5) words are allowed.
4. To move between words, tap the **Fwd** and **Back** buttons.
5. To remove a word, tap Delete.

## Q: Select Wired Sensor# Reports (0 to 1)

**DEFAULT: (1) Enabled**

Wired sensors can be programmed to trigger a report to the Central Station or not.

- The default setting (1) *Enabled* activates reporting for this wired sensor number.
- To prevent reporting for this wired sensor number, select (0) *Disabled*.

## Q: Select Wired Sensor# Chime (00 to 13)

**DEFAULT: (0) Disabled**

Each wired sensor can be set to sound a "ding-dong" chime and/or sound its voice descriptor when the sensor is triggered.

- The default setting (0) *Disabled* inactivates the chime for this wired sensor.
- If a chime and/or voice is required for this wired sensor, choose one of the other chime options (next page):

## Sensor Chime

Code	Sensor Chime
[0]	Disabled
[1]	Voice Only
[2]	Ding-Dong with Voice #1
[3]	Ding-Dong #2
[4]	Ding-Dong with Voice #2
[5]	Ding-Dong #1
[6]	Ding-Ding
[7]	Ding-Ding with Voice
[8]	Ding-Dong #3
[9]	Ding-Dong with Voice #3
[10]	Chime #1
[11]	Chime #1 with Voice #1
[12]	Chime #2
[13]	Chime #2 with Voice #2

## Wireless (RF) Key Fob Programming

The Control Panel can be programmed with up to eight (8) RF key fobs.

Programming the fobs into the Control Panel involves selecting the sensor number for a particular device, setting or learning the serial number, and selecting the other options for the sensor.

**IMPORTANT:** RF key fobs 1 - 8 report to the Control Panel as sensors 51 - 58 (opening/closing, emergency, and low battery reports).

Fob#	Reports as Sensor#
1	51
2	52
3	53
4	54
5	55
6	56
7	57
8	58

See *Figure 49 Key Fob Programming Outline* for the steps required to program fobs into the Control Panel. The options that can be set for each fob are:

- **Q3: Select Fob Number.** Select key fob number 1-8.
  - **Q: Select Fob # Used.** Select (0) Disabled or (1) Enabled.
  - **Q: Select Fob # Equipment Code.** Select the four (4)-digit equipment code that corresponds to the appropriate keyfob. See [“Equipment Codes” on page 37](#).
  - **Q: Enter Fob # Other Equipment Code.** Enter the special equipment code. This is only required when the **Key Fob # Equipment Code** is set to (0000) Other.
  - **Q: Enter Fob # Serial #.** Enter the serial number (typically a label on the keyfob or the keyfob packaging) or tap **Shift** then **Learn** to place the panel into learning mode. Then trip the keyfob to transmit the serial number to the panel.
  - **Q: Select Fob # Equipment Age.** Specify whether the sensor is a (0) New or (1) Existing sensor.
  - **Q: Select Fob # Emergency Key.** Choose the function of double-tapping the top buttons (0) Disabled, (1) Auxiliary Alarm, (2) Audible Alarm, (3) Silent Panic, or (4) Fire.
  - **Q: Select Fob # Key # Can Disarm.** Choose (0) Disabled or (1) Enabled to specify if the key fob is allowed to disarm the system.
  - **Q: Construct Fob # Voice Descriptor.** Construct the name assigned for the keyfob announcement. See [“Voice Descriptors” on page 35](#).
  - **Q: Select Fob # Arm No Delay.** Choose if key fob will arm the system instantly without an exit delay.
  - **Q: Select Fob # Key # Output.** Select an action for the key fob auxiliary button.

## Key Fob Programming Outline

### Q3: RF Key Fob Programming Outline

Figure 49 Key Fob Programming Outline

<b>Q1: SELECT FOB #</b>	ENTER ON KEYPAD OR PRESS ← OR → TO SELECT FROM LIST
PRESS ↓ FOR NEXT OPTION	
<b>Q: SELECT FOB # USED</b>	ENTER ON KEYPAD OR PRESS ← OR → TO SELECT FROM LIST
PRESS ↓ FOR NEXT OPTION	
<b>Q: SELECT FOB # EQUIPMENT CODE</b>	ENTER ON KEYPAD OR PRESS ← OR → TO SELECT FROM LIST
PRESS ↓ FOR NEXT OPTION	
<b>Q: ENTER FOB # OTHER EQUIPMENT CODE</b> (Only appears if (0000) Other was selected in previous question)	ENTER ON KEYPAD
PRESS ↓ FOR NEXT OPTION	
<b>Q: ENTER FOB # SERIAL NUMBER</b>	ENTER ON KEYPAD OR PRESS shift OR learn THEN SEND SIGNAL FROM KEY FOB
PRESS ↓ FOR NEXT OPTION	
<b>Q: SELECT FOB # EQUIPMENT AGE</b>	ENTER ON KEYPAD OR PRESS ← OR → TO SELECT FROM LIST
PRESS ↓ FOR NEXT OPTION	
<b>Q: SELECT FOB # EMERGENCY KEY</b>	ENTER ON KEYPAD OR PRESS ← OR → TO SELECT FROM LIST
PRESS ↓ FOR NEXT OPTION	
<b>Q: SELECT KEY FOB # KEY 2 CAN DISARM</b>	ENTER ON KEYPAD OR PRESS ← OR → TO SELECT FROM LIST
PRESS ↓ FOR NEXT OPTION	
<b>Q: CONSTRUCT FOB # VOICE DESCRIPTOR</b>	PRESS shift FOR EACH WORD ENTER ON KEYPAD OR PRESS ← OR → TO SELECT FROM LIST
PRESS ↓ FOR NEXT OPTION	
<b>Q: SELECT FOB # ARM NO DELAY</b>	ENTER ON KEYPAD OR PRESS ← OR → TO SELECT FROM LIST
PRESS ↓ FOR NEXT OPTION	
PRESS ↓ TO FINISH PROGRAMMING SENSOR THEN PRESS edit next TO PROGRAM THE NEXT SENSOR OR PRESS skip TO JUMP TO Q2: WIRED SENSOR PROGRAMMING	

Scroll between options using the ← and → arrows. Move to the previous or next prompt by tapping the ↑ and ↓ arrows.

1. To program another sensor tap **Next**.
2. To exit programming, tap **Skip**, then **End**, and then **Exit**. Upon exit, the panel takes several seconds to restart.
3. TIP: Tap Skip to jump to question Q4. See [“RF Keypad Programming Questions” on page 47](#).

## Summary of RF Key Fob # Screen

After setting all the options for a key fob, the **Summary of Fob #** screen is displayed. The screen can also be displayed for programmed keyfobs during keyfob program editing by tapping the **Sum** button.

- While programming each key fob remember that the ← and → arrow buttons step through each of the key fob numbers.
- To return to programming, tap the **Edit Current** or **Edit Next** buttons.
- Tapping **Skip** goes to question number Q4 (RF Keypad Programming). See [“Wireless \(RF\) Keypad Programming” on page 46](#).

## RF Key Fob Programming Questions

### Q3: Select Fob # (1 to 8)

Up to eight (8) wireless four (4)-button key fobs can be used with each Control Panel. Key fobs reports as sensors 51-58. The options for each fob are programmed with sub-option questions.

- Begin by entering the fob number or select it using the ← or → arrows.
- Program the key fobs by using ↑ and ↓ arrows to select the sub-options.

**NOTE:** To skip RF key fob programming, tap Skip to jump from question Q3 to question Q4 (RF keypad programming). See [“RF Keypad Programming Questions” on page 47](#).

### Q: Select Fob # Used (0 to 1)

**DEFAULT: (0) Unused**

Key fobs can be used with the Control Panel or not.

- The default setting (0) *Unused* sets all key fobs as unused.
- To enable programming for this key fob, select (1) *Used*.

### Q: Select Key Fob # Equipment Code (0-9999)

**DEFAULT: (0000) Other**

The key fob equipment code defines the sensor’s manufacturer and type.

- The default setting is (0000) *Other*.
- Select (0866) *2GIG 4-button Key Fob* remote for a 2GIG-KEY2 key fob remote.
- Select (0577) *Existing Key Fob* for an existing key fob remote.

**NOTE:** Only 2GIG 4-Button Key Fob Remotes are compatible with this system.

### Q: Enter Key Fob # Other Equipment Code (0-9999)

**DEFAULT: 0**

**NOTE:** This question is only displayed if (0000) *Other* is selected for a key fob’s equipment code.

- The equipment code is a four (4)-digit code that is assigned to the model of key fob being used.
- Enter the equipment code number for the key fob.

**Q: Enter Fob # Serial Number (7 Digits)****DEFAULT: 0000000**

Key fob serial numbers can be manually entered or learned from the fob.



- For manual entry, enter the fob number that was logged for the fob being programmed. Use the **Shift** button to access alpha characters.
- For automatic entry, tap **Shift**, then tap **Learn**. The Control Panel will wait for a fob transmission. Trigger the fob being programmed and the Control Panel will learn the fob's serial number.

**Q: Select Fob # Equipment Age (0 to 1)****DEFAULT: (0) New**

The Control Panel can be used with new or existing key fobs.

- If this fob is new for the installation, leave the default setting of *(0) New*.
- If this fob is already installed, select *(1) Existing*.

**Q: Select Fob # Emergency Key (0 to 4)****DEFAULT: (0) Disabled**

Pressing the  and  buttons on a key fob at the same time for 5 seconds can trigger an emergency alarm.

- The default setting *(0) Disabled* inactivates the emergency function the fob #.
- To enable the emergency function for this fob, select one (1) of the four (4) options:
  - (0) Disabled
  - (1) Auxiliary Alarm
  - (2) Audible Alarm
  - (3) Silent Panic
  - (4) Fire

**Q: Select Fob# Key # Can Disarm (0 to 1)****DEFAULT: (1) Enabled**

As an installer, consult the user as to whether to set the key fob to allow disarming the Control Panel with the key fob's  buttons. If the user wants the key fob used as a stationary wall fob, it can also be set to prevent using the key fob to disarm the system.

- The default setting *(1) Enabled* allows the fob to disarm the system.
- To not allow the fob to disarm the system, select *(0) Disabled*.

**Q: Construct Fob# Voice Descriptor****DEFAULT: (#) Keyfob**

The voice descriptor are the actual the words that the Control Panel use for this fob for low battery *announcements* and log entries. Up to five (5) words are allowed.

1. Tap **Insert** to place a word from the vocabulary into the data entry field.
2. Use the ← or → arrows to scroll through the words, or enter the word's three (3)-digit index number.
3. Tap **Insert** again for the next word. Up to five words are allowed.
4. To remove a word, tap **Delete**.

**Q: Select Fob (#) Arm No Delay (0 to 1)****DEFAULT: (0) Disabled**

Key fobs can be set to arm the Control Panel with or without an entry delay.

- The default setting *(0) Disabled* sets this fob to arm the system *with* an entry delay.
- To set this fob to arm the system without an entry delay, select *(1) Enabled*.

**Wireless (RF) Keypad Programming**

The Control Panel can be programmed with up to four (4) RF keypads or RF touch screen keypads.

**NOTE:** RF Keypads 1 - 4 report to the Control Panel as sensors 59 - 62 (for emergency, and low battery reports).

RF Keypad	Reporting Codes
Keypad 1	Reports as sensor #59
Keypad 2	Reports as sensor #60
Keypad 3	Reports as sensor #61
Keypad 4	Reports as sensor #62

- User Codes #1 - #8 are reported for openings and closings
- User Code #0 is reported for Quick Arming The following options can be set for each RF keypad:
  - **Select RF Keypad Number.** Select keypad number 1-4.
  - **Select RF Keypad # Used.** Enable or disable the keypad.
  - **Select RF Keypad # Equipment Code.** Select the equipment code for the keypad. See ["Equipment Codes" on page 37](#).
  - **Select RF Keypad # Other Equipment Code.** If you selected *(0000) Other*, enter the special equipment code.
  - **Select RF Keypad # Serial #.** Enter the serial number from the keypad or "learn" by sending a signal.
  - **Select RF Keypad # Equipment Age.** Select *(0) New* or *(1) Existing*.
  - **Select RF Keypad # Emergency Keys.** Select *(1) Enabled* or *(0) Disabled*.
  - **Construct RF Keypad # Voice Descriptor.** Construct the name assigned for the keypad announcement. See ["Voice Descriptors" on page 35](#).



## RF Keypad Programming Outline

### Q4: RF Key Pad Programming Outline

Figure 50 Key Pad Programming Outline

<b>Q1: SELECT KEYPAD #</b>	ENTER ON KEYPAD OR PRESS ← OR → TO SELECT FROM LIST
PRESS ↓ FOR NEXT OPTION	
<b>Q: SELECT RF KEYPAD # USED</b>	ENTER ON KEYPAD OR PRESS ← OR → TO SELECT FROM LIST
PRESS ↓ FOR NEXT OPTION	
<b>Q: SELECT RF KEYPAD # EQUIPMENT CODE</b>	ENTER ON KEYPAD OR PRESS ← OR → TO SELECT FROM LIST
PRESS ↓ FOR NEXT OPTION	
<b>Q: ENTER RF KEYPAD 3 OTHER EQUIPMENT CODE</b> <small>(Only appears if (0000) Other was selected in previous question)</small>	ENTER ON KEYPAD
PRESS ↓ FOR NEXT OPTION	
<b>Q: ENTER RF KEYPAD SERIAL NUMBER</b>	ENTER ON KEYPAD OR PRESS shift OR learn THEN SEND SIGNAL FROM KEY FOB
PRESS ↓ FOR NEXT OPTION	
<b>Q: SELECT RF KEYPAD # EQUIPMENT AGE</b>	ENTER ON KEYPAD OR PRESS ← OR → TO SELECT FROM LIST
PRESS ↓ FOR NEXT OPTION	
<b>Q: SELECT RF KEYPAD # EMERGENCY KEYS</b>	ENTER ON KEYPAD OR PRESS ← OR → TO SELECT FROM LIST
PRESS ↓ FOR NEXT OPTION	
<b>Q: CONSTRUCT FOB # VOICE DESCRIPTOR</b>	PRESS shift FOR EACH WORD ENTER ON KEYPAD OR PRESS ← OR → TO SELECT FROM LIST
PRESS ↓ FOR NEXT OPTION	
PRESS ↓ TO FINISH PROGRAMMING SENSOR THEN PRESS edit next TO PROGRAM THE NEXT SENSOR OR PRESS skip TO JUMP TO Q2: WIRED SENSOR PROGRAMMING	

Scroll between options using the ← and → arrows. Move to the previous or next prompt by tapping the ↑ and ↓ arrows.

- To program another sensor tap **Next**.
- To exit programming, tap **Skip**, then **End**, and then **Exit**. Upon exit, the panel takes several seconds to restart.
- Tap **Skip** to jump to question Q5.

### Summary of RF Keypad Screen

After setting all the options for a sensor, the RF keypad summary screen is displayed. The screen can also be displayed for programmed RF keypads by tapping the **Sum** button.

- To return to programming, tap the **Edit Current** or **Edit Next** buttons.
- Tapping **Skip** goes to question Q5 (Control Panel programming).
- To exit programming, tap **Skip** then **End** and **Exit**. Upon exit, the Control Panel takes several seconds to restart.

## RF Keypad Programming Questions

### Q4: Select RF Keypad # (1 to 4)

Up to four (4) wireless keypads can be programmed for use with each Control Panel. The options for each sensor are programmed with sub-option questions:

- Begin by entering the RF Keypad number or select it using the ← or → arrows.
- Program the RF keypads by using the ↑ and ↓ arrows to select the sub-options.

To skip RF Keypad programming, tap **Skip** to jump from question Q4 to question Q5 (Exit Delay programming).

### Q: Select RF Keypad (#) Used (0 to 1)

**DEFAULT: (0) Unused**

Users can use RF keypads together with a Control Panel or not.

- The default setting (0) *Unused* sets all RF keypads as unused.
- To enable programming for this RF keypad, select (1) *Used*.

### Q: Select RF Keypad (#) Equipment Code (0-9999)

**DEFAULT: (0000) Other**

The *RF keypad equipment code* defines the sensor's manufacturer and type.

- The default setting is (0000) *Other*.
- Select (0867) *2GIG Wireless Keypad*.
- Select (1059) *2GIG TS1 Wireless Touchscreen Keypad*.

**NOTE:** 2GIG Wireless Touch Screen Keypad is not intended for UL 985: Household Burglar-Alarm System Units installations.

### Q: Enter RF Keypad # Other Equipment Code (0-9999)

**DEFAULT: 0**

**NOTE:** This question is only displayed if (0000) *Other* is selected as the RF keypad's equipment code.

**IMPORTANT:** The equipment code is a four (4)-digit code that is assigned to the appropriate keypad model being used.

- Enter the equipment code number for the RF Keypad.

### Q: Enter RF Keypad# Serial Number (7 Digits)

**DEFAULT: 0000000 or RF Keypad (#) Keypad ID (read-only)**

Serial numbers for standard wireless keypads can be manually entered or learned from the keypad. For Wireless Touch Screen Keypads, serial numbers can **only** be learned from the keypad. Read-only with Keypad ID's refer to the installer being unable to manually input an id.

Standard Keypads:

- For manual entry, enter the Wireless Keypad that was logged for the keypad being programmed. Tap the **Shift** button to access alpha characters.
- For automatic entry, tap **Shift** and then **Learn**. This places the Control Panel into learning mode. When you trigger the keypad the sensor for the keypad being programmed, it sends its serial number to the Control Panel.

Wireless Touch Screen Keypads (only available in some regions):

- For Wireless Touch Screen Keypads tap **Learn**. The Control Panel displays the "Pair with TS-1. Initiating learning process". Tap the keypad's **Pair with Panel** button. When complete, the keypad and the Control Panel display "The learn operation succeeded" message.
- The Control Panel displays "RF Keypad (#1-4)" to identify the keypad.

- The keypad displays “Network ID: xxxx” which is its unique serial number.
- Tap **OK** on both the Control Panel and the Wireless
- Touch Screen Keypad to continue.

**NOTE:** The Wireless Touch Screen Keypad will display “*The security system is temporarily not operational*” after learning the Keypad. This is normal, and will be displayed anytime the Control Panel is in system configuration (programming) mode.

### Q: Select RF Keypad# Equipment Age (0 to 1)

**DEFAULT: (0) New**

The Control Panel can be used with new or existing RF keypads.

- If this RF Keypad is new for the installation, leave the default of (0) *New*.
- If this RF Keypad is already installed, select (1) *Existing*.

### Q: Select RF Keypad# Emergency Keys (0 to 1)

**NOTE:** This step is not displayed for Wireless Touch Screen keypads.

**DEFAULT: (1) Enabled**

Standard wireless keypads have 24-hour emergency buttons labeled Fire and Police.

- The default (1) *Enabled* enables this RF Keypad’s emergency keys.
- To disable this RF Keypad’s emergency keys, select (0) *Disabled*, the keys will not be able to trigger an alarm or report.

**NOTE:** The RF Keypad’s POLICE button triggers a silent alarm if programming question Q16: *Police Emergency Key (0-2)* is set to (2) *Silent Panic*. See “[Q16: Police Emergency Key](#)” on page 50.

**IMPORTANT:** To ensure that a signal is sent, instruct the end user to tap and hold down the emergency key on the keypad until its indicator light illuminates.

### Q: Construct RF Keypad# Voice Descriptor

**DEFAULT: (#) Keypad**

The voice descriptor is the words the Control Panel will announce for this RF Keypad. Up to five words are allowed.

1. Tap **Insert** to place a word from the vocabulary into the data entry field.
2. Use the ← or → arrows to scroll through the words, or enter the word’s 3-digit index number.
3. Tap **Insert** again for the next word. Up to five words are allowed.
4. To remove a word, tap **Delete**.

# Control Panel Programming

## Programming Questions

### Q1: RF Sensor Programming

To learn about RF sensor programming, see [“Wireless \(RF\) Sensor Programming” on page 38.](#)

### Q2: Wired Sensor Programming

To learn about wired sensor programming, see [“Wired Sensor Programming” on page 41.](#)

### Q3: RF Key Fob Programming

To learn about RF key fob programming, see [“Wireless \(RF\) Keyfob Programming” on page 44.](#)

### Q4: RF Keypad Programming

To learn about RF keypad programming, see [“Wireless \(RF\) Keypad Programming” on page 46.](#)

### Q5: Exit Delay, in Seconds (45-120)

#### DEFAULT: 60 seconds

The default minimum setting of 60 seconds is required for ANSI/SIA CP-01 compliance. The delay time can be increased without affecting compliance.

The exit delay timer can be set to a value between 45 to 120 seconds.

- The default setting *60* sets the exit delay to 60 seconds.
- To change the exit delay timer, enter a value between *45-120* seconds.

### Q6: Entry Delay 1, in Seconds (30-240)

#### DEFAULT: 30 seconds

*The default minimum setting of 30 seconds is required for ANSI/SIA CP-01 compliance.*

**NOTE:** For compliance with ANSI/SIA CP-01, the total number of minutes for the combination of Q6: Entry Delay 1 and Q35: Abort Window Dialer Delay cannot exceed one (1) minute.

The timer for Entry Delay 1 can be set to a value between 30 to 240 seconds.

- The default setting *30* sets the timer to 30 seconds.
- To change the setting, enter a value between *30-240* seconds.

### Q7: Entry Delay 2, in Seconds (30-240)

#### DEFAULT: 45 seconds

*The default minimum setting of 45 seconds is required for ANSI/SIA CP-01 compliance.*

**NOTE:** For compliance with ANSI/SIA CP-01, the total number of minutes for the combination of Q7: and Q35:

*Abort Window Dialer Delay cannot exceed one (1) minute.*

The timer for Entry Delay 1 can be set to a value between 30-240 seconds:

- The default setting of *45* sets the timer to 45 seconds.
- To change the timer setting, enter a value between *30-240* seconds.

### Q13: 2-Way Voice (0-2)

#### DEFAULT: (1) Stay On Line

The Control Panel supports two (2)-way voice communications between the subscriber and the Central Station operator over the LTE (Cellular) Radio Module (if installed) after an alarm has been reported.

- The *(1) Stay On Line* allows two (2)-way audio over the cell radio.
- Selecting *(2) Stay On Line, Including Fire and CO Alarms* allows 2-way audio over cell radio during fire and CO alarms.
- To turn off the two (2)-way audio feature OFF, select *(0) Disabled*.

When the Control Panel connects with the operator, it will beep once per second (every 6 seconds with a cell radio connection). The beep alternates between two tones and indicates the Control Panel is waiting for a session command. If the operator fails to issue a command within one (1) minute (or three (3) minutes if using the cell radio connection), the call is terminated. Once the operator presses a command option, the beeps will stop and a five (5)-minute audio session will start (or three (3)-minute audio session if using the cell radio connection).

When two (2)-way voice communications have been established, the Central Station operator can use the following telephone keys to control the communications. Each time the operator uses a command key, the session is extended for five additional minutes (three minutes with a cell radio connection). During the last minute of communications, the system beeps two (2) times every 15 seconds to indicate that time is running out.

- Tap **1** to enable Talk mode one (1)-way communication from the Central Station to the premises and allows the operator to talk.
- Tap **2** to enable VOX mode two (2)-way communications from the Central Station to the premises.
- Tap **3** to enable Listen mode one (1)-way communication from the premises to the Central Station.
- Tap **7** to extend the session five (5) minutes without changing the mode of operation.
- Tap **9** to end the audio session and terminate the call.

### Q14: Silent Panic/Burglary Listen Only

#### DEFAULT: (1) Enabled

The Control Panel supports audio listen-in of the subscriber premises from the Central Station after a silent panic (police emergency), silent burglary, or duress alarm has been reported.

- The default setting *(1) Enabled* allows the Central Station to use listen-in over audio after a silent panic, silent burglary, or duress alarm.
- This option is permanently set and cannot be disabled.

## Q16: Police Emergency Key (0-2)

### DEFAULT: (1) Audible

The Control Panel's panic emergency button action can be programmed. The panic emergency button is displayed by pressing the **+** button.

- The default (1) *Audible* allows the panic emergency button to sound an audible alarm.
- For silent activation, select (2) *Silent Panic*.
- To not display the panic emergency button, select (0) *Disabled*.

**NOTE:** Setting this programming question for (2) *Silent Panic* makes the Police button on all RF keypads silent also.

## Q17: Fire Emergency Key (0-1)

### DEFAULT: (1) Audible

The Control Panel's fire emergency button can be enabled or disabled. The fire emergency button is displayed by pressing the Control Panel's **+** button.

- The default setting (1) *Audible* allows the fire emergency button to sound an audible alarm.
- To disable and not display the fire emergency button, select (0) *Disabled*.

## Q18: Emergency Key (0-1)

### DEFAULT: (1) Audible

The Control Panel's emergency button can be enabled or disabled. The panel's emergency button is displayed by pressing the **Emergency** **+** button on the panel.

- The default setting (1) *Audible* sounds an audible alarm when the button is pressed.

To disable this button, select (0) *Disabled*.

**NOTE:** If all three (3) Emergency buttons are disabled, the Control Panel displays a message when its **Emergency** **+** button is pressed.

## Q19: Quick Arming (0-1)

### DEFAULT: (1) Enabled

Quick arming allows the subscriber to arm the system without having to enter a user code. If Open/Close Reports are being sent, quick arming is reported as *User 0*.

- The default (1) *Enabled* allows quick arming.
- To turn off quick arming, select (0) *Disabled*.

## Q20: Swinger Shutdown Count (1-6)

### DEFAULT: (2) Two Trips

*The minimum setting of (2) Two Trips is required for ANSI/SIA CP-01 compliance. This default setting can be increased to three or more trips without affecting ANSI/SIA CP-01 compliance.*

An unwanted series of multiple faults (usually caused by a bad contact or sensor) is called a "swinger". Swinger shutdown sets the maximum number of alarms that any sensor or hardware loop can trigger during a single arming period.

**NOTE:** CO and Smoke detector alarms are not limited by the swinger shutdown count. Other types of 24-hour zones are limited by the swinger shutdown count.

- The default setting (2) **Two-Trips** sets the swinger shutdown count at two (2) trips.
- To change this count, select (1-6).

## Q21: Siren Supervision Time (0-3)

### DEFAULT: (0) Disabled

The wiring connection to the external sounder can be supervised. If the wiring to the sounder is cut for 15, 30, or 45 seconds, a bell trouble report can be sent to the Central Station.

- The default setting (0) *Disabled* turns external sounder supervision OFF.
- To supervise the external sounder wiring, select:
  - (1) *15 Seconds*
  - (2) *30 Seconds*
  - (3) *45 Seconds*

## Q22: CS Lack of Usage Notification Time (0-255)

### DEFAULT: 7 days

If this system has not been armed for a specified number of days, inactivity reports can be sent to the Central Station.

- The default setting is 7 days.
- To change the duration, select a value between 1 to 255 days.
- To turn this feature OFF, select 0 days.

## Q23: Radio Modem Network Failure Time (0-255)

### DEFAULT: 30 Minutes

**NOTE:** LTE (Cellular) Radio Module must be installed to use this function.

If the optional LTE (Cellular) Radio Module loses its cellular connection, specify the amount of down time that must pass before triggering a trouble condition.

- The default setting is 30 minutes.
- To specify a different amount of time, enter a value between one (1) to 255 minutes.
- To turn this feature OFF, select 0 minutes.

**NOTE:** After cellular service is restored for five (5) minutes, the trouble condition automatically clears.

## Q24: Radio Modem Network Failure Causes Trouble (0-1)

### DEFAULT: (1) Enabled

**NOTE:** LTE (Cellular) Radio Module must be installed to use this function.

Selects whether the Control Panel will sound and display trouble if the optional LTE (Cellular) Radio Module has lost its cellular connection. The trouble sounder can be silenced by the user at the Control Panel (cell radio trouble is logged regardless of this setting). When the cellular radio module connection is restored, the trouble indications automatically clear.

- The default (1) *Enabled* allows radio module failure trouble indications.
- To turn off radio module failure trouble indications, select (0) *Disabled*.

## Q25: Radio Modem Network Failure Reports (0-1)

**DEFAULT: (1) Enabled**

**NOTE:** LTE (Cellular) Radio Module must be installed to use this function.

If the optional LTE (Cellular) Radio Module loses its cellular connection, the Control Panel can report the fault and restore communication.

- The default (1) *Enabled* allows radio module failure/restore reporting.
- To turn off radio module failure/restore reporting, select (0) *Disabled*.

## Q26: Auto Stay (0-1)

**DEFAULT: (1) Enabled**

This feature must be enabled for ANSI/SIA CP-01 compliance.

When auto stay is enabled and the system is armed in the **Away** mode, if an exit/entry sensor is not violated during the Exit Delay, the system will arm in the **Stay** mode.

- The default setting is (1) *Enabled* which turns the auto-stay feature ON.
- To turn this feature off, select (0) *Disabled*.

**NOTE:** If the system is remotely armed in Away mode using a key fob, mobile app, or computer, the auto-stay feature will not switch the system to Stay mode.

## Q27: Exit Delay Restart (0-1)

**DEFAULT: (1) Enabled**

*This feature must be enabled for ANSI/SIA CP-01 compliance.*

When Exit Delay restart is enabled, re-entering the premises through an exit/entry door during the Exit Delay will restart the Exit Delay. The restart of the Exit Delay will only occur one time; further violations of an exit/entry sensor will not extend the Exit Delay.

- The default setting (1) *Enabled* turns this feature ON.
- To turn this feature OFF, select (0) *Disabled*.

## Q28: Quick Exit (0-1)

**DEFAULT: (1) Enabled**

The quick exit feature allows the user to start the Exit Delay while the system is armed. When this feature is enabled, a **Quick Exit** button appears on the Security screen. Tap **Quick Exit** while the system is armed when the user wants to leave through an exit/entry door. After the Exit Delay expires, the system will return to being armed in the mode it was in before (either **Stay** or **Away** mode).

- The default setting (1) *Enabled* turns this feature ON.
- To turn this feature OFF, select (0) *Disabled*.

## Q29: Periodic Test, in Days (0-255)

**DEFAULT: 30 Days**

Recurring test reports can be automatically sent to the Central Station at a specified number of days.

- The default setting is **30**. This sends an automatic test report to the Central Station every 30 days.
- To change the number of days, enter a value between one (1) to 255 days.
- To disable this feature, select (0) *Disabled*.

## Q31: Cancel Time, in Minutes (5-255)

**DEFAULT: 5 minutes**

The minimum setting for ANSI/SIA CP-01 compliance is 5 minutes. The number of minutes can be increased without affecting ANSI/SIA CP-01 compliance.

A cancel report will be sent to the Central Station after an alarm, if the system is disarmed within the programmed time.

- The default setting for the cancellation time is five (5) minutes.
- To extend this time interval, enter a value between six (6) to 254 minutes.
- To always send a cancel report when the system is disarmed after an alarm, enter 255.

**NOTE:** See Q32: *Cancel Display* for information on displaying when a cancel report is sent.

## Q32: Cancel Display (0-1)

**DEFAULT: (1) Enabled**

This feature must be enabled for ANSI/SIA CP-01 compliance.

A cancel report will be sent to the Central Station after an alarm, if the system is disarmed within the programmed time. The Control Panel can also display that a cancel report was sent.

- The default setting (1) *Enabled* enables the cancel display feature.
- To turn off the cancel display feature, select (0) *Disabled*.

**NOTE:** See Q31: *Cancel Time, in Minutes* for information on setting the cancel report trigger time.

## Q33: Cross Sensor 47-48 (0-1)

**DEFAULT: (0) Disabled**

The Control Panel can be programmed so sensors 47 and 48 must both be violated during a set time to trigger an alarm. This is called "cross sensor" verification. When enabled, if only one sensor (47 or 48) is violated, the alarm will not trigger, but a trouble report will be sent for the sensor that triggered.

**NOTE:** CO and Fire zone cannot be used for cross sensors.

- The default setting (0) *Disabled* turns the cross sensor feature OFF.
- To turn the cross sensor feature ON, select (1) *Enabled*.

**NOTE:** See Q34: *Cross Sensor Timeout, in Seconds* for information on setting the cross sensor timeout.

## Q34: Cross Sensor Timeout, in Seconds (10-120)

**DEFAULT: 10 Seconds**

The cross sensor timeout is the maximum period of time allowed between violation of sensors 47 and 48 that will trigger an alarm. If both sensors are violated within this time period, an alarm will be triggered. If both sensors are not violated within this time period, an alarm will not be triggered.

**NOTE:** Cross sensor verification must be enabled with Q33: *Cross Sensor 47-48* for this feature to function.

- The default setting for the cross sensor timeout is 10 seconds.
- To change the timeout duration, enter a value between 11 to 120 seconds.

## Q35: Abort Window Dialer Delay (0-2)

### DEFAULT: (1) 30 Seconds

The default minimum setting for ANSI/SIA CP-01 compliance is 30 seconds.

The delay time can be increased to 45 seconds without affecting ANSI/SIA CP-01 compliance only if the combination of Q35 and Q6 or Q7 does not exceed one (1) minute.

**NOTE:** The dialer delay can be disabled for each sensor without affecting ANSI/SIA CP-01 compliance. See [“RF Sensor Programming Questions” on page 39](#).

The system delays calling the Central Station to allow the user enough time to cancel a false alarm before it is reported.

- The default setting is (1) 30 Seconds.
- To change the setting, select (0) 15 Seconds or (2) 45 Seconds.

## Q36: Burglary Bell Cutoff (0 to 4)

### DEFAULT: (0) 4 Minutes

When a burglary alarm is triggered, the bell will sound until the burglary bell cutoff time expires.

- The default setting for the burglary bell cutoff is (0) 4 Minutes.
- To change the cutoff time, select an option below.

#### Burglary Bell Cutoff Time

(0) 4 Minutes

(1) 8 Minutes

(2) 12 Minutes

(3) 16 Minutes

(4) Unlimited

**NOTE:** The 24-hour Auxiliary Alarm Zone (08) does not follow the burglary bell cutoff time and will sound the Control Panel's local alarm until a User Code is entered. The Auxiliary Alarm Zone does not trigger the external siren (if used).

## Q37: Fire Bell Cutoff (0-4)

### DEFAULT: (0) 4 Minutes

When a fire alarm is triggered, the bell sounds until the fire bell cutoff time expires.

- The default setting (0) 4 Minutes sets the burglary bell cutoff to four (4) minutes.
- To change the fire bell cutoff time, select an option below:

#### Fire Bell Cutoff Time

(0) 4 Minutes

(1) 8 Minutes

(2) 12 Minutes

(3) 16 Minutes

(4) Unlimited

## Q38: Time to Detect AC Loss, in Minutes (0-30)

### DEFAULT: (10) 10 Minutes

When AC power is lost, the system displays a power loss alert .

after the specified time length. When power is restored, the alert is automatically cleared after one (1) minute.

- The default detection timer for displaying the alert message is (10) 10 Minutes.
- To change the detection timer, enter a value between 0 to 30 minutes.

**NOTE:** After the AC power alert  is displayed or clears, the AC power loss report or AC power restore report can be sent to the Central Station immediately, or at a random time, see Q39: Random AC Loss Report Time.

**NOTE:** The Control Panel's AC Power Icon immediately displays the power status. See [“AC Power ON/OFF” on page 25](#).

## Q39: Random AC Loss Report Time (0-1)

### DEFAULT: (1) Enabled

This feature allows the system to report AC power loss and AC power restore at a random time of up to 45 minutes after the event occurs. This helps to reduce Central Station congestion due to a wide-spread power outage affecting many Control Panels at once. The random AC power status report timer is triggered based on the time set by Q38: Random AC Loss Report Time.

- The default setting (1) Enabled turns this feature ON.
- To turn this feature OFF, select (0) Disabled.

**NOTE:** The installer code must be unique from the master user code and all other user codes.

## Q43: Installer Code (4 Digits)

### DEFAULT: 1561

The installer code is a unique code that installation technicians use to access the Installer Toolbox on the Control Panel.

- The default installer code is 1561.
- To change the installer code, enter a new four (4)-digit code.

**IMPORTANT:** If you change the installer code, always write it down so that you can access the system later.

## Q44: Lock Installer Programming (0-2)

### DEFAULT: (0) Disabled

The installer programming lockout feature is provided to prevent takeovers. The Control Panel can be set to limit an installer's access to programming questions after a period of 48 hours. The 48-Hour Lockout timer starts when the installer exits System Configuration mode.

Three (3) options are available:

- Unlimited full access to programming (no lockout).
- Limited access to programming after 48 hours.
- No access to programming after 48 hours. The default setting (0) Disabled selects unlimited full access to programming (no lockout).

To deny access to programming after 48 hours, select (1) No Access to Programming.



If you select (2) Limited Access to Programming the installer will be able to view, but not change the following attributes after the system has run for 48 hours, the Central Station phone number, Central Station account number, lock installer programming, download ID, and default lockout fields.

After the 48 hour lockout timer has locked out the system, the timer can be reset through the cell radio or PC download by remotely setting this question to (0) or (2). Setting the option to (0) or (2) will restart the 48 hour lockout timer.

## Q45: Lock Default Programming (0-2)

### DEFAULT: (0) Default All

The Control Panel may be able to be hard reset (or soft reset from the Installer Toolbox) to its factory default values depending on the value entered for this programming question.

The Control Panel is hard reset by pressing and holding the  and  buttons while applying power to the Control Panel.

The default lockout feature is provided to prevent takeovers. Three options are available: allow default of all options, allow default of some but not all options, not allow default of any options.

- The default setting of (0) *Default All* allows resetting the Control Panel to all its factory defaults.
- To allow resetting the Control Panel to all its factory defaults except the Central Station phone number, Central Station account number, lock installer programming, download ID, and default lockout fields, select (1) *Default All Except CSID, Account/ Phone, Lockouts*.
- To deny hard and soft resetting of the Control Panel, select (2) *Default None*.

If option 1 or 2 is selected, the option takes effect after the system runs for 48 hours. This allows the installer to go back and make changes if required.

## Q46: Trouble Doesn't Sound at Night (0-1)

### DEFAULT: (1) Enabled

**NOTE:** For *UL 985: Household Fire Warning System Units* installations, this setting must be set to (0) *Disabled*

The Control Panel will sound trouble beeps caused by AC loss, system low battery, sensor low battery or RF supervision, failure to communicate, Control Panel tamper while disarmed, and cell radio faults.

To prevent annoying the subscriber, the system can be set to suppress trouble beeps from sounding from 10 PM to 9 AM. The trouble alerts are still displayed and immediately reported to the Central Station, and can be acknowledged, but they won't sound beeps until after 9 AM.

If the trouble condition(s) self-clear or are acknowledged before 9 AM, no trouble beeps sound after 9 AM (the conditions are still recorded in the event log).

- The default setting (1) *Enabled* suppresses trouble beeps from 10 PM to 9 AM.
- To allow trouble beeps at any time, select (0) *Disabled*.

## Q47: Trouble Resound After Hold Off (0-7)

### DEFAULT: (0) Disabled

Fire and CO sensors are required to re-sound trouble beeps every four hours until the trouble is resolved, even if the trouble is acknowledged at the Control Panel. The Control Panel can be set to delay re-sounding these types of trouble beeps for 1-7 days.

**NOTE:** This feature is not allowed in UL 985 installations. The setting must be (0) *Disabled* in this grade of installation.

- The default setting (0) *Disabled* allows trouble beeps for CO and fire sensors to re-sound every four (4) hours after being acknowledged
- To delay re-sounding trouble beeps for CO and Fire sensors, select (1-7) days

## Q49: Programming Mode Entry Reports to CS (0-1)

### DEFAULT: (0) Disabled

A report can be sent to the Central Station any time installer programming mode is entered and exited.

- The default setting (0) *Disabled* prevents reporting programming mode entry and exit.
- To report programming mode entry and exit, select (1) *Enabled*.

**NOTE:** This report can only be sent through the telephone dialer. It is not supported through the LTE (Cellular) Radio Module.

## Q50: Trouble Reports to CS (0-1)

### DEFAULT: (1) Enabled

Trouble reports can be sent to the Central Station when any sensor trouble condition occurs.

- The default setting (1) *Enabled* allows reporting sensor trouble conditions.
- To not report sensor trouble conditions, select (0) *Disabled*.

**NOTE:** This setting does not affect trouble reports caused by Control Panel conditions, only trouble reports caused by sensors.

## Q51: Manual Bypass Reports to CS (0-1)

### DEFAULT: (0) Disabled

Manual bypass reports can be sent to the Central Station when any sensor has been manually bypassed by the user.



- The default setting (0) *Disabled* prevents sending manual bypass reports.
- To allow sending manual bypass reports, select (1) *Enabled*.

## Q52: AC Loss Reports to CS (0-1)

### DEFAULT: (1) Enabled

AC power loss reports can be sent to the Central Station if the Control Panel loses AC power.

- The default setting (1) *Enabled* allows AC power loss reports.
- To turn off AC power loss reports, select (0) *Disabled*.

**NOTE:** The AC power will have to be absent from the Control Panel for the time set by programming question Q38 before the AC power loss trouble alert  is displayed (the default is 10 minutes). If programming question Q39 is enabled, the actual AC power loss report will occur at a random time of up to four hours after the AC power loss trouble alert  is displayed.

**NOTE:** The Control Panel's AC power icon displays the power status immediately. A red "X" over the icon indicates no AC power.

### Q53: System Low Battery Reports to CS (0-1)

#### DEFAULT: (1) Enabled

Low battery reports can be sent to the Central Station if the Control Panel's battery tests low.

- The default (1) *Enabled* allows Control Panel low battery reports.
- To turn off Control Panel low battery reports, select (0) *Disabled*.

### Q54: RF Low Battery Reports to CS (0-1)

#### DEFAULT: (1) Enabled

Sensor low battery reports can be sent to the Central Station if a sensor battery tests low and sends a low battery transmission to the Control Panel.

- The default setting is (1) *Enabled* and allows the system to send low battery reports for sensors.
- To turn this feature OFF, select (0) *Disabled*.

### Q55: Opening Reports to CS (0-1)

#### DEFAULT: (0) Disabled

Opening reports can be sent to the Central Station each time the system is disarmed. The user or key fob number is indicated in the opening report.

- The default setting (0) *Disabled* prevents opening reports.
- To allow opening reports, select (1) *Enabled*.

### Q56: Closing Reports to CS (0-1)

#### DEFAULT: (0) Disabled

Closing reports can be sent to the Central Station each time the system is armed. The user or key fob number is indicated in the closing report. If Quick Arming is enabled, User #0 is indicated for the closing report.

- The default setting (0) *Disabled* prevents closing reports.
- To allow closing reports, select (1) *Enabled*.

### Q57: Alarm Restore Reports to CS (0-1)

#### DEFAULT: (0) Disabled

Alarm restore reports can be sent to the Central Station after an alarm when either the bell timeout has been reached or the system is disarmed. If alarm restores are enabled and swinger shutdown is set to two, a restore will be reported if the sensor is closed (normal state) at bell cutoff or becomes closed after bell cutoff. If swinger shutdown is set to one, a restore will only be sent if the sensor is closed at the time of disarm. Restores are not sent if a sensor is in swinger shutdown until the time of disarm and the sensor is closed.

- The default setting (0) *Disabled* prevents alarm restore reports.
- To allow alarm restore reports, select (1) *Enabled*.

### Q58: Trouble Restore Reports to CS (0-1)

#### DEFAULT: (1) Enabled

Trouble restore reports can be sent to the Central Station when any sensor trouble condition clears.

- The default setting (1) *Enabled* allows the system to send reports when trouble conditions are restored.
- To turn this feature OFF, select (0) *Disabled*.

### Q59: Bypass Restore Reports to CS (0-1)

#### DEFAULT: (0) Disabled

Bypass restore reports can be sent to the Central Station when any sensor that was force bypassed or manually bypassed gets restored.



- The default setting (0) *Disabled* prevents bypass restore reports.
- To allow bypass restore reports, select enabled (1) *Enabled*.

### Q60: AC Restore Reports to CS (0-1)

#### DEFAULT: (1) Enabled

AC power restore reports can be sent to the Central Station when the Control Panel regains AC power after an AC power loss.

- The default setting (1) *Enabled* allows AC power restore reports.
- To turn off AC power restore reports, select (0) *Disabled*.

**NOTE:** The AC power will have to be restored to the Control Panel for one minute before the AC power loss trouble alert  automatically clears. If programming question Q39 is enabled, the actual AC power restore report will occur at a random time of up to four hours after the AC power loss trouble alert  has cleared.

**NOTE:** The Control Panel's AC power icon displays the power status. A red "X" over the icon indicates no AC power.

### Q61: System Low Battery Restore Reports to CS (0-1)

#### DEFAULT: (1) Enabled

When a low battery condition is restored on the Control Panel, the system can send a restore report to the Central Station.

- The default setting (1) *Enabled* allows the system to send reports when low battery conditions are restored.
- To turn this feature OFF, select (0) *Disabled*.

### Q62: RF Low Battery Restore Reports to CS (0-1)

#### DEFAULT: (1) Enabled

Sensor low battery restore reports can be sent to the Central Station if a sensor battery had tested low and is now OK.

- The default setting (1) *Enabled* allows sensor low battery restore reports.
- To turn off sensor low battery restore reports, select (0) *Disabled*.



## Q64: Smart Test Reports

### DEFAULT: (0) Disabled

Smart test reports are a way to reduce Central Station traffic. If smart test reports are enabled and regular periodic test reports are enabled, any non-test report to the Central Station (alarm, restore, trouble, etc.) during the normal operation of the system will reset the periodic test report timer. Periodic test reports would only be sent if the Control Panel has not reported in any way to the Central Station.

- The default setting (0) *Disabled* prevents smart test reports.
- To allow smart test reports, select (1) *Enabled*.

## Q65: RF Jam Causes Trouble (0-1)

### DEFAULT: (0) Disabled

The system can monitor the Control Panel's sensor receiver and detect whether a transmitter is stuck on the air causing jamming. When jam detect is enabled, the Control Panel will indicate a trouble condition if RF jamming is detected.

**NOTE:** This programming question only functions if trouble reports are enabled with programming question Q50.

- The default setting (0) *Disabled* turns RF jam detection OFF.
- To turn on RF jam detection, select (1) *Enabled*.

## Q66: Daylight Saving (0-1)

### DEFAULT: (1) Enabled

The Control Panel can adjust its displayed clock and internal clock for Daylight Saving Time (DST). If the cell radio is used, the time will be automatically adjusted regardless of this setting. The system default is set to use the current start (March) and end (November) dates for the United States. The DST start and end dates can be adjusted as follows:

- The default setting (1) *Enabled* turns ON the DST clock for the system.
- To turn off the DST clock, select (0) *Disabled*.

**NOTE:** If enabled, respond to programming questions Q67, Q68, Q69, and Q70 to modify the start and stop values for DST.

## Q67: Daylight Saving Start Month (01-12)

### DEFAULT: (03) March

- The default DST start month is set to (03) *March*.
- To change the start month for your country, region, or state, enter the desired month, (01-12) *January - December*.

## Q68: Daylight Saving Start Monday (1-7)

### DEFAULT: (2) 2nd Sunday

- The default (2) sets the second Sunday as the daylight saving start week.
- To change the start week, enter the 1st, 2nd, 3rd, 4th, last, second from last, third from last (1-7) as the daylight saving start week.

## Q69: Daylight Saving End Month (01-12)

### DEFAULT: (11) November

- The default (11) *November* defines the daylight saving end month.
- To change the end month for your country, region, or state, enter the desired month, (01-12) *January - December*.

## Q70: Daylight Saving End Sunday (1-7)

### DEFAULT: (1) 1st Sunday

- The default setting (1) *1st Sunday* defines the daylight saving end week.
- To change the end week, enter the 1st, 2nd, 3rd, 4th, last, second from last, third from last (1-7) as the daylight saving end week.

## Q71: System Tamper Causes Trouble (0- 1)

### DEFAULT: (1) Enabled

A tamper switch on the Control Panel detects if the case has been opened. The system can be programmed so that a tamper switch activation will cause a trouble indication if the system is disarmed, and an alarm if the system is armed.

- The default (1) allows the Control Panel tamper switch to trigger trouble when the system is disarmed, and alarm when the system is armed.
- To have the system ignore the Control Panel tamper switch, select (0) *Disabled*.

## Q72: Quick Bypass (0-1)

### DEFAULT: (0) Disabled

Normally, sensors that are violated (open) at the time the system is armed will require the user to enter their code to force bypass them. The Control Panel can be programmed so that when the system is armed with open sensors, a code is not required to bypass the open sensor(s) and complete the arming.

- The default setting (0) *Disabled* requires entering a code to bypass sensors.
- To allow bypassing sensors without a code, select (1) *Enabled*.

## Q73: Disarming Keyfob After Alarm (Alert) (0-1)

### DEFAULT: (0) Disabled

The system can produce a unique sound when it's disarmed with a key fob after an alarm has occurred. Four beeps will sound from the Control Panel's speaker, four chirps will sound from the external sounder (if installed). This feature serves as a safety alert to the user so they can enter the protected premises with caution.

- The default setting (0) *Disabled* will not cause a unique sound when disarming after an alarm.
- To cause unique sound when disarming after an alarm, select (1) *Enabled*.

## Q74: Keyfob Arm/Disarm Confirmation (0-1)

### DEFAULT: (0) Disabled

The system can produce a unique sound when it's armed or disarmed with a key fob. The Control Panel's speaker will sound one beep when arming and two beeps when disarming. The external sounder (if installed) will sound one chirp when arming and two chirps when disarming (four beeps after an alarm if Q73 is enabled). This feature indicates to the user that their key fob signal was received by the Control Panel in case other arm/disarm indications (armed LED, etc.) are not available or visible to the user.

- The default setting (0) *Disabled* will not cause a unique sound when controlled by a key fob.
- To cause a unique sound when controlled by a key fob, select (1) *Enabled*.

## Q75: Auto UnBypass for Manual Bypass (0-1)

### DEFAULT: (1) Enabled

Violated (open) sensors can be manually bypassed by the user through the User Toolbox or force bypassed at the time of arming.

Force bypassed sensors automatically have their bypasses removed when the system is disarmed.

Manually bypassed sensors can have their bypass automatically removed at disarming or have their bypasses remain in place.

- The default setting (1) *Enabled* automatically removes bypasses from manually bypassed sensors when the system is disarmed.
- To have manually bypassed sensors remain bypassed when the system is disarmed, select (0) *Disabled*.

## Q76: Force Bypass Reports (0-1)

### DEFAULT: (0) Disabled

The system can report which sensors have been force bypassed by the user when the system is armed. Forced bypassed sensors are always recorded in the event log, regardless of the setting of this programming question.

- The default setting (0) *Disabled* prevents reporting forced bypassed sensors.
- To report forced bypassed sensors, select (1) *Enabled*.

## Q77: Event Log (0-3)

### DEFAULT: (3) All Events

To control the amount of event log entries, the events that get recorded into the system's event log can be selected by type. This setting filters the events that populate the event log.

- The default setting (3) *All Events* records all events in the event log.
- To choose different options, select one of these filters:

#### Event Log Filters

(0) Disabled (no events logged)

(1) All Events Except Open, Closing, and Bypass

(2) All Events Except Open and Closing

(3) All Events

## Q79: Z-Wave Feature (0-3)

### DEFAULT: (3) (3) Enabled on Panel; Rules Disabled, Remote Access Enabled

The Z-Wave home services feature can be enabled or disabled with various remote control access options.

- The default setting (3) *Enabled on Panel; Rules Disabled, Remote Access Enabled* displays the **Services** button, but will show a message that the feature is currently disabled and the user should call the installer.
- To hide the **Services** button, select (0) *Disabled and Hidden*.
- To show the **Services** button but disable it from use, select (1) *Disabled but Visible*.
- To show the **Services** button and disable off-site remote control, select (2) *Enabled on Panel, Remote Access Disabled*.

## Q80: Z-Wave Switches Feature (0 to 1)

### DEFAULT: (1) Enabled

Display of the Home Service's **Switches** button can be enabled or disabled.

**NOTE:** This programming question only functions if Q79: Z-Wave Feature is set to (2) or (3).

- The default setting (1) *Enabled* shows the **Switches** button.
- To hide the Switches button, select (0) *Disabled*.

## Q81: Z-Wave Thermostats Feature (0 to 1)

### DEFAULT: (1) Enabled

Show or hide the Home Service's Thermostats button on the Control Panel.

**NOTE:** This programming question only functions if Q79: Z-Wave Feature is set to (2) or (3).

- The default setting (1) *Enabled* shows the **Thermostats** button.
- To hide the Thermostats button, select (0) *Disabled*.

## Q82: Z-Wave Door Locks Feature (0-1)

### DEFAULT: (1) Enabled

Display of the Home Service's **Door Locks** button can be enabled or disabled. This programming question only functions if the Z-Wave feature enable question Q79: *Z-Wave Feature* is set to (2) or (3).

- The default setting (1) *Enabled* shows the Door Locks button.
- To hide the Door Locks button, select (0) *Disabled*.

## Q83: Select Temperature Display Units (0-1)

### DEFAULT: (0) Degrees Fahrenheit

The Home Service's Z-Wave thermostat display screens can show the temperature in degrees Fahrenheit or degrees Celsius.

**NOTE:** This programming question only functions if Q79: Z-Wave Feature is set to (2) or (3) and Q81: Z-Wave Thermostats Feature is set to (1) *Enabled*.

- The default setting is (0) *Degrees Fahrenheit*.
- To change the setting, select (1) *Celsius*.

**NOTE:** The setting you select here also changes the display units shown on the weather forecast on the Control Panel's Home screen.

## Q84: Services Require Master Code (0 to 1)

### DEFAULT: (0) Disabled

The **Services** button can be configured to require the use of the master user code to access Services.

- The default setting (0) *Disabled* overrides the requirement to enter a master user code to access the **Services** menu.

To require the use of the master user code to access the **Services** menu, select (1) *Enabled*.

When enabled then the master user code is required to access the Services and the Z-Wave device configurations. This keeps unauthorized users from being able to change Z-Wave settings, such as temperature, lights and locks.

## Q85: Master User Access to Z-Wave Toolbox (0-1)

### DEFAULT: (0) Disabled

The Z-Wave Toolbox menu can be set to require the use of the master user code or the installer code. By default, the installer code is required for users to access the Z-Wave Toolbox.

- The default setting (0) *Disabled* requires users to enter the installer code to access the Z-Wave Toolbox menu and all of its features, including the Advanced Toolbox.
- To require the use of the master user code or the installer code to access the Z-Wave Toolbox menu, select (1) *Enabled*.

**NOTE:** When (1) *Enabled*, the Installer code will still be required to access the Advanced Toolbox menu. This prevents end users from adding or removing Z-Wave devices.

## Q86: Disable Siren After Two-Way Audio (0-1)

### DEFAULT: (0) Disabled

This setting enhances system operation in personal emergency applications and also provides the dealer with the option of the siren sounding until the bell cut off or to the end of a two-way-voice session.

- The default setting (0) *Disabled* will cause the siren to resume after two-way audio (if the bell cut off timer has not expired).
- (1) *Enabled* will cause the siren to shut off after a two-way audio session.

## Q87: Keyfob/Remote Arming Mode on System Not Ready (0-2)

### DEFAULT: (0) Auto Bypass with Zone Participation on Restore

This setting controls how the system will react when there are open sensors and the system is armed remotely.

- The default setting (0) *Disabled* will automatically bypass all sensors that are open when the system is armed remotely. If a sensor restores while the system is armed, the sensor's bypass will be removed, and the sensor will be ready to trigger an alarm.
- To automatically bypass all sensors that are open when the system is armed remotely, and keep all bypasses in place during the arming cycle, even if a sensor restores, select (1) *Auto-Bypass*.
- To prevent arming remotely when any sensor is open, select (2) *Arm Only When Ready*.

## Q89: Allow Backlight Always On (Demo Mode) (0-1)

**NOTE:** May cause ghost/image retention.

### DEFAULT: (0) Disabled

When set to (1) *Enabled* the customer can program the "always on" option for backlight programming. Due to a small percentage of image "ghosting" on the panel (because the backlight never goes off), this question was created but has been defaulted to (0) *Disabled*.

## Q90: Energy Feature (0 to 1)

### DEFAULT: (0) Disabled and Hidden

Select (1) *Disabled but Visible* to show but not activate the energy features. You can also select (2) *Enabled* to turn the energy feature ON.

## Q91: Radio Modem Supplier

### DEFAULT: (0) No Radio Modem Supplier

**NOTE:** If you enable Q44: *Select Lock Installer Programming*, you will not be able to change this setting.

**NOTE:** For compliance with UL 1610, Q91: *Select Radio Modem Supplier (0 to 5)* must be set to (1) *Radio Modem Supplier 1*.

Select the option that corresponds to the appropriate supplier. Options include:

Option	Supplier
(0) No Radio Modem Supplier	This is the default setting.
(1) Radio Modem Supplier 1	Alarm.com
(2) Radio Modem Supplier 2	
(3) Radio Modem Supplier 3	
(4) Radio Modem Supplier 4	
(5) Radio Modem Supplier 5	SecureNet
(6) Radio Modem Supplier 6	

## Q92: Select Network Device (0 to 1)

### DEFAULT: (0) None

When enabled, the (1) *Go!Bridge* option provides the installer with the following questions to program the Go!Bridge IP Communicator settings into the Control Panel

### Q: Network Device ID (read only)

Tap Learn. Then go to the Go!Bridge device and tap the Learn button. For details, see the Go!Bridge IP Communicator Installation Instructions.

### Q: Select Configuration Source

#### DEFAULT: (0) DHCP

Select between (1) *Static* or (2) *DHCP* (Dynamic Host Configuration Protocol). The default setting is (0) *DHCP* and is the most common selection. The other option is (1) *Static* and requires entry of a Device IP Address, Gateway IP Address, and Subnet Mask.

### Q: Enter Device IP Address

#### DEFAULT: 000.000.000.000

**NOTE:** This question only requires an answer if you selected

(1) *Static* in Q: *Select Configuration Source*.

Use the numeric keypad to enter the IP Address for the Go!Bridge IP Communicator.

### Q: Enter the Gateway IP Address

#### DEFAULT: 000.000.000.000

**NOTE:** This question only requires an answer if you selected

(1) *Static* in Q: *Select Configuration Source*.

Use the numeric keypad to enter the IP Address for the access point to the external network. Typically, this is the IP Address of the local network router.

### Q: Enter the Subnet Mask

#### DEFAULT: 000.000.000.000

**NOTE:** This question only requires an answer if you selected

(1) *Static* in Q: *Select Configuration Source*.

Use the numeric keypad to enter the IP Address for the subnet mask for the network.

**Q: Select Port # (1 to 8)****DEFAULT: (1) Port 1****NOTE:** Typically, you will skip this question unless additional programming is required.

Select the port number for the backend server. After configuring the required port, tap Next on the Control Panel.

- (1) Port 1
- (2) Port 2
- (3) Port 3
- (4) Port 4
- (5) Port 5
- (6) Port 6
- (7) Port 7
- (8) Port 8

**Q: Select Used (0 to 1)****DEFAULT: (0) Disabled****NOTE:** Typically, you will skip this question unless additional programming is required.It is recommended that you always select the default setting (0) *Disabled*. If you choose (1) *Enabled*, you will be prompted to enter the port value.**Q: Enter Port Value (0 to 65535)****DEFAULT: (0) Disabled****NOTE:** Typically, you will skip this question unless additional programming is required.It is recommended that you always select the default setting (0) *Disabled*. If you select (1) *Enabled* in **Q: Select Used (0 to 1)**, use the numeric keypad to enter the port value.**NOTE:** The *port value* is the port number for Transmission Control Protocol (TCP) communication. Port numbers can range from 0 to 65535.**Q: Enter Port Forward IP Address****DEFAULT: 000.000.000.000**

Typically, you will simply accept the default IP Address value that appears.

**Q93: Enter Broadband Network Failure Time (1-255)****DEFAULT: 30 Minutes****NOTE:** The Go!Bridge IP Communicator must be installed to use this function.

This option sets the amount of time required for triggering a trouble condition if the system detects that the broadband network has lost its connection. After the connection has been restored, the trouble condition clears.

- The default failure detection setting is 30 minutes.
- To choose a different failure detection time, enter the number of minutes between 1-255.

**Q94: Select Broadband Network Failure Causes Trouble (0 to 1)****DEFAULT: (1) Enabled****NOTE:** The Go!Bridge IP Communicator must be installed to use this function.

This option specifies whether or not the Control Panel will sound and display a trouble alert if the Go!Bridge IP Communicator loses its broadband connection. The trouble alert can be silenced by the user at the Control Panel (broadband trouble is logged regardless of this setting). When the broadband connection is re stored, the trouble indications automatically clear.

- The default setting (1) *Enabled* allows Go!Bridge network failure trouble indications.
- To turn off Go!Bridge trouble indications, select (0) *Disabled*.

**Q95: Select Broadband Network Failure Reports (0 to 1)****DEFAULT: (1) Enabled****NOTE:** The Go!Bridge IP Communicator must be installed to use this function.

If the Go! Bridge IP Communicator loses its broadband connection, the Control Panel can report the fault.

- The default setting is (1) *Enabled* which turns broadband network failure reporting ON.
- To turn broadband network failure reporting OFF, select (0) *Disabled*.

**Q96: Select Send Report 3 Times on Panel Tamper (0 to 1)****DEFAULT: (1) Enabled****NOTE:** For compliance with UL 1610, this question must be set to (1) disabled.

This option configures the system to transmit three (3) reports to the Central Station when the system detects that the panel's backplate is in a tamper condition.

- **(1) Enabled.** The system transmits three (3) reports to the Central Station.
- **(0) Disabled.** The system only transmits a single report to the Central Station.

**Q97: Select Sound on Normal Closing Acknowledgment (0 to 1)****DEFAULT: (1) Enabled**

Configures the system to emit a sound when the system acknowledges that an open sensor has closed (i.e., returned to its normal state).

- **(1) Enabled.** The system emits a sound on sensor closing.
- **(0) Disabled.** No sound is emitted on sensor closing.

**NOTE:** For compliance with UL 1610, this question must be set to (1) *Enabled*. In addition, **Q91** must be set to (1) *Radio Modem Supplier 1*.

# Final Installation Setup

## Exiting Programming (System Configuration)

After programming the Control Panel, all the changes need to be saved in memory. After saving, the programmed settings will remain in memory, even after a total power loss.

1. After setting all the required programming values for the sensors and the Control Panel, tap **End**.
2. Review the **Summary of System Configuration screen**. Use the ↓ and ↑ arrows to scroll through the listing. Verify that each option is set correctly.

Figure 51 Summary of System Configuration Screen

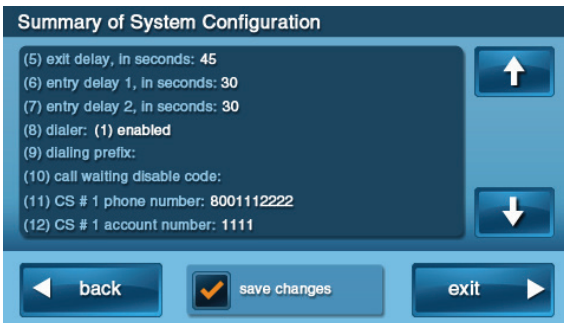

3. To save the programming changes, be sure the Save Changes option is checked. To exit without saving programming changes un-check the **Save Changes** option (for verification, an additional confirmation screen appears). Tap **Exit**.
4. The Control Panel takes a few seconds to restart and display the Home screen.

## Customizing the Installation

After programming the Control Panel, go to the User Toolbox and customize the system to suit the installation. To access the User Toolbox, do the following:

1. From the **Home** screen, tap **Security**.
2. From the Security screen, tap, **Menu**.
3. From the Menu screen, tap **Toolbox**.
4. Enter the *master user code* (the default master user code is 1111).
5. Tap **User Management**.
6. To add, change, or delete a user code, tap a **User #** button. The system asks to confirm the code entered. Be sure to set a Duress Code as User #8.

Figure 52 User Management Screen

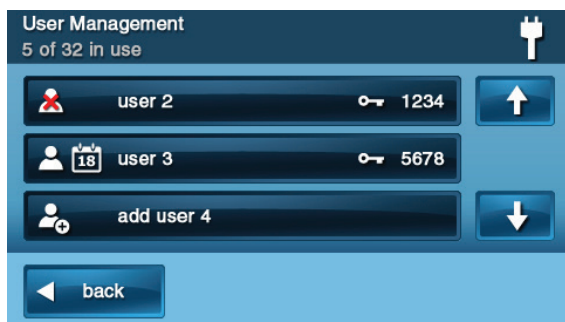

**NOTE:** User codes 0000, 0001, and the Installer Code are not permitted.

7. Setup each user code with the User Access Option screen. Each User Code can be set to be currently valid or not, or to have conditional validity. Refer to the *User Guide* for details on setting User Code Access Schedules. When done, tap **Back**.
8. At the **Toolbox (1 of 3)** screen, tap **Brightness/Volume**. Then set the brightness level for the display screen and the volume for the chime & voice. When done, tap **OK**.

Figure 53 Brightness/Volume Screen

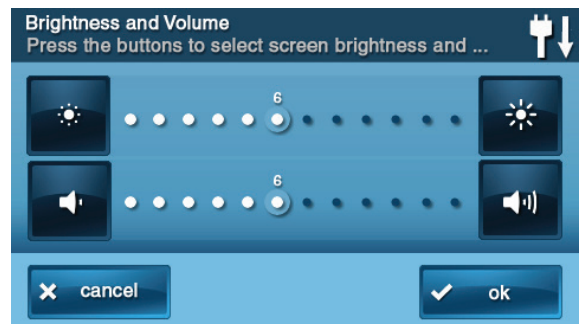

9. At the Toolbox (1 of 3) screen, tap → to go to the Toolbox (2 of 3) screen.
10. Tap Backlight Timeout. Then tap the button that corresponds to the number of seconds or minutes the backlight turns OFF after it is idle. When done, tap **OK**.

Figure 54 Back Light Timeout Screen

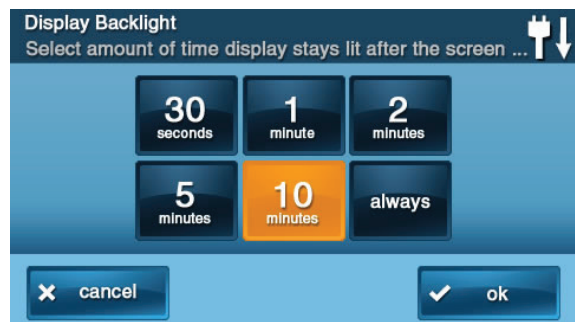

**NOTE:** If the LTE (Cellular) Radio Module is properly installed and registered, the system automatically sets the date and time for you. Use the following steps only if you want to change the date and time.

- At the Toolbox (2 of 3) screen, tap Set Date. Then use the ↓ and ↑ arrows to set the month, day, and year. When done, tap OK.

Figure 55 Set Date Screen

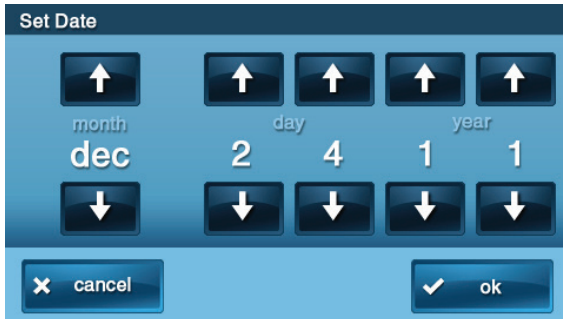

- At the Confirmation screen, tap OK.
- At the Toolbox (2 of 3) screen, tap Set Time. Then use the ↓ and ↑ arrows to set the hours, minutes, and AM/PM. When done, tap OK.

Figure 56 Select Time Screen



- At the Confirmation screen, tap OK.
  - To return to the Security screen, tap Back.
  - OR
  - To return to the Home screen, press .

## Installer Testing

When installation and programming is complete, use the option in the Installer Toolbox to test for proper system operations.

### Access the Installer Toolbox

To access the Installer Toolbox:

1. At the Home screen, tap the system logo in the lower-right corner.
2. At the Enter a Code screen, enter the installer code (the default installer code is 1561).

The Installer Toolbox(1 of 3) screen appears.

### Disable/Enable Sounder

When testing the Control Panel, both the internal and external sounder (if installed) will be activated. To limit noise during the testing process, the Control Panel offers an option to disable the sounder.

#### Disable the Sounder

To disable the sounder:

1. At the Installer Toolbox (1 of 2) screen, tap Disable Sounder.
2. At the Disable Sounder? screen, tap OK. NOTE: The internal sounder emits a siren for two (2) seconds. If an external sounder is connected, four (4) chirps are emitted.
3. At the Sounder Disabled screen, tap OK.

**NOTE:** The sounder will be automatically re-enabled in 30 minutes or you can manually enable it. See “Enable the Sounder”, below.

4. While disabled, the Sounder Disabled icon appears in the status bar.

Figure 57 Sounder Disabled Icon

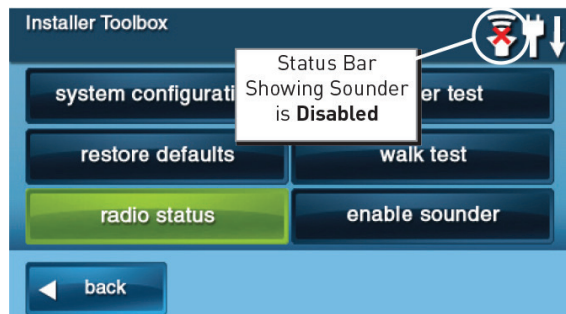

### Enable the Sounder

If the sounder is disabled, you can manually re-enable it as follows:

1. At the Installer Toolbox screen, tap Enable Sounder.
2. At the Sounder Enabled screen, tap OK.

### Sensor Type (Zone) Report Test

To verify that the Central Station correctly receives reports from each zone (sensor type):

1. **Notify the Central Station.** Because the system sends test signals, notify the Central Station that you will be testing the system.
2. **Fire Test.** Trigger a 24-Hour fire sensor (if installed) or tap the Control Panel's **Emergency** (+) button and then tap the **Fire** button (if enabled). Wait for approximately 45 seconds for the report to complete, then disarm the console.
3. **Panic Test.** Trigger a 24-Hour Panic sensor (if installed) or tap the Control Panel's **Emergency** (+) button and then tap the **Panic** button (if enabled). Wait about 45 seconds for the report to complete, then disarm the console.
4. **Emergency Test.** Trigger a 24-Hour emergency sensor (if installed) or tap the **Emergency** (+) button (if enabled), wait about 45 seconds for the report to complete, then disarm the console.
5. **Burglary Test.** Arm the system, then trigger a burglary sensor, wait for the system to go into alarm mode, then wait about 45 seconds for the report to complete, and then disarm the console.
6. **Verify Tests with Central Station.** Check with the Central Station that each zone (sensor type) was reported, then inform the Central Station that the testing is complete.

### Walk Test

Radio quality can vary when there is background noise on the operating frequency. Examples of background noise sources include telephones, microwaves, high-frequency digital products, and other radio communications.

To determine the best location to mount each sensor, it is recommended that you place each sensor in the desired mounting location and then perform a Walk Test. This helps you to identify whether the desired location has good/weak signal strength. When you find a location with good signal strength, you can then mount the sensor.

To place the panel into Walk Test mode:

1. At the Installer Toolbox (1 of 2) screen, tap Walk Test.

**NOTE:** When placing the Control Panel into Walk Test mode, you have 25 minutes to complete the test before the screen times out. The system also sends a “Start Test” report to the Central Station and beeps once every 30 seconds. During the last five (5) minutes of the test, the system beeps two (2) times every 30 seconds and the **T** icon flashes in the status bar.

- When the **System Test: Sensors** screen appears, you can tap the ↓ and ↑ arrows to scroll through the sensor list.

Figure 58 System Test: Sensors Screen



- Walk to the first sensor in the list, and then activate that sensor to test it.

When the panel receives the signal, it emits (3) beeps and then GREEN or RED bars show the signal strength. The greater the number of bars, the higher the strength. If the signal is sufficient, a check mark appears. If insufficient, an “x” appears.

Figure 59 System Test: Sensors Screen/Signal Strength

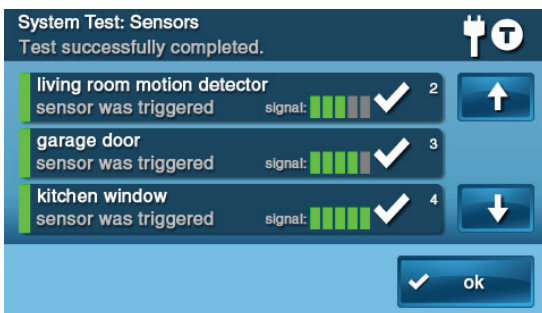

- Repeat the test for each sensor in the list. If you are testing a sensor with multiple loops, (for example, a Smoke/Heat/Freeze alarm), wait 15 seconds between each loop’s test.

**NOTE:** If a sensor is not detected, no signal will register. Tap OK. Then at the Sensors Test Failed screen, tap OK.

- At the System Test: Console screen, tap each button to test the panel’s LED buttons and audio.

Figure 60 System Test: Console

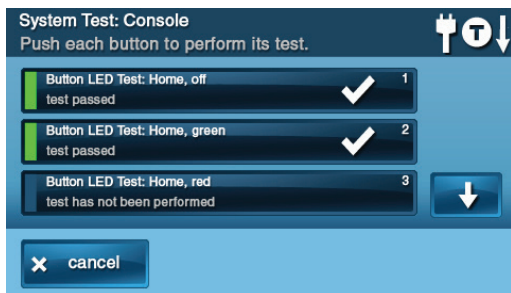

- When the console tests are complete, tap **OK**. When the test is successfully completed, tap **OK** to exit Walk Test mode. The system sends a “Stop Test” report to the Central Station.

## Radio Status Test

If the LTE (Cellular) Radio Module is installed in the Control Panel, use the **Radio Status** screen to view signal strength, serial number, registration status, and other information for the cellular connection. This is a helpful tool to use when troubleshooting the installation.

## Cell Phone Test

To perform a cell phone test:

- At the **Installer Toolbox** screen, tap **Radio Status**.

Figure 61 Installer Toolbox: Radio Status

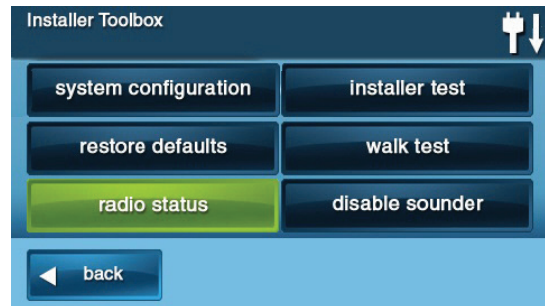

- At the **Radio Status** screen, tap **Cell Phone Test**.

Figure 62 Radio Status Screen

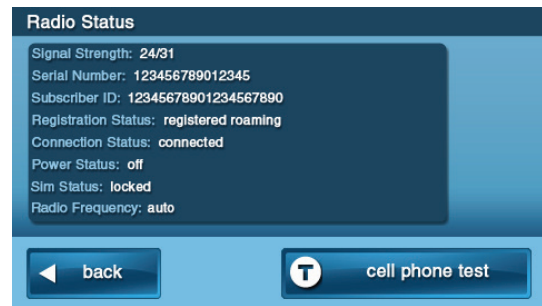

The Cell Phone Test screen appears to reveal status messages and test results

Figure 63 Cell Phone Test Screen

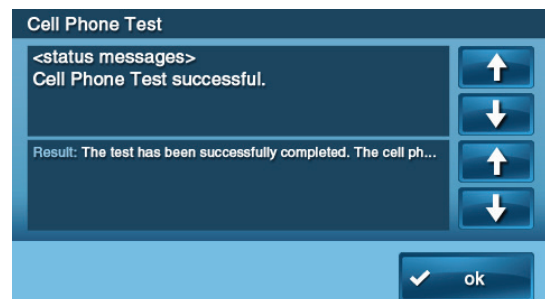

- When the results appear, tap the ↓ and ↑ arrows to review the messages:

- RED text indicates the tested signal strength is zero, too low, or that the LTE (Cellular) Radio Module is unregistered.
- ORANGE text indicates the connection is idle and the LTE (Cellular) Radio Module is registered.
- GREEN text indicates good signal strength and that the LTE (Cellular) Radio Module is registered.

- When the results are successful, tap **OK** to return to the Toolbox (3 of 3) screen.



## Restore Default System Configuration

You can restore the Control Panel settings back to its factory defaults. There are two (2) types of reset options: *Soft* and *hard*.

### Soft Reset

A *soft-reset* lets you select which settings to restore back to the factory defaults.

To perform a soft-reset:

1. At the **Installer Toolbox** screen, tap the **Restore Default** button. The Restore Default System Configuration screen appears.

**Figure 64** Restore Default System Configuration Screen

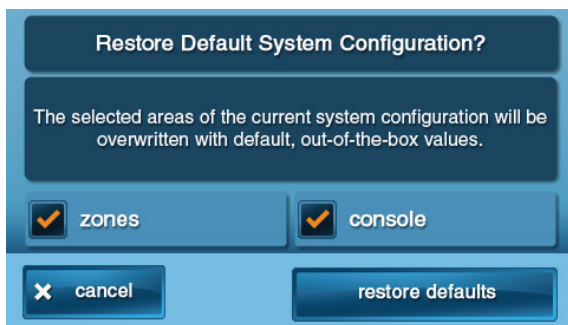

2. At the Restore Default System Configuration screen, select one or both check-boxes:
  - **Zones.** Place a check-mark in this box to replace data for ALL sensors with the factory default values.

AND/OR

- **Console.** Place a check-mark in this box to replace all of the programming answers with the factory defaults. This erases the user codes, resets the backlight timeout to five (5) minutes, and resets the Brightness/Volume settings.

**IMPORTANT:** This action does not restore the factory default settings for Z-Wave questions Q79-Q83.

### Hard Reset

A *hard-reset* restores all of the programming settings back to the factory defaults.

**NOTE:** Before performing a hard reset, *Q44: Lock Installer Programming* must be set to option (1) or (2) and *Q45: Lock Default Programming* must be set to (0). See [“Q44: Lock Installer Programming \(0-2\)” on page 52.](#)

To perform a hard reset:

1. Remove the Control Panel cover and completely disconnect all power to the Control Panel.
2. On the inside back of the Control Panel, plug in the backup battery.
3. Tap and hold down the **Emergency** (+) and **Home** (□) buttons.
4. Continue to hold down the **Emergency** (+) and **Home** (□) buttons and then connect DC Power to the Control Panel.
5. Release the buttons only after both the **Emergency** (+) and **Home** (□) buttons are lit and the Control Panel screen appears.

## Regulatory Information

### Wireless Product Notice

Radio controls provide a reliable communications link and fill an important need in portable wireless signaling; however, there are some limitations which must be observed.

- For U.S. installations only: The radios are required to comply with FCC Rules and Regulations as Part 15 devices. As such, they have limited transmitter power and therefore limited range.
- A receiver cannot respond to more than one transmitted signal at a time and may be blocked by radio signals that occur on or near their operating frequencies, regardless of code settings.
- Changes or modifications to the device may void FCC compliance.
- Infrequently used radio links should be tested regularly to protect against undetected interference or fault.
- A general knowledge of radio and its vagaries should be gained prior to acting as a wholesale distributor or dealer, and these facts should be communicated to the end users.

### FCC Notice

This equipment generates and uses radio frequency energy and if not installed and used properly, that is, in strict accordance with the manufacturer's instructions, may cause interference to radio and television reception. It has been type tested and found to comply with the limits for a Class B computing device in accordance with Part 15 of FCC Rules, which are designed to provide reasonable protection against such interference in a residential installation. However, there is no guarantee that interference will not occur in a particular installation. If this equipment does cause interference to radio or television reception, which can be determined by turning the equipment off and on, the user is encouraged to try to correct the interference by one or more of the following measures:

- Relocate the Console away from the TV/radio receiver.
- Plug the Console into a different wall outlet so that the Console is on a different branch circuit.
- Re-orient the TV/radio antenna.
- If necessary, the user should consult the dealer or an experienced radio/television technician for additional suggestions.

### Industry Canada Notices

**NOTICE:** The Ringer Equivalence Number (REN) assigned to each terminal device provides an indication of the maximum number of terminals allowed to be connected to a telephone interface. The termination on an interface may consist of any combination of devices subject only to the requirement that the sum of the ringer equivalence numbers of all the devices does not exceed five (5).

**NOTICE:** The Industry Canada label identifies certified equipment. This certification means that the equipment meets certain telecommunications network protective, operational and safety requirements. The Department does not guarantee the equipment will operate to the user's satisfaction.

Before installing this equipment, users should ensure that it is permissible to be connected to the facilities of the local telecommunications company. The equipment must also be installed using an acceptable method of connection. The customer should be aware that compliance with the above conditions may not prevent degradation of service in some situations.

Repairs to certified equipment should be made by an authorized Canadian maintenance facility designated by the supplier. Any repairs or alterations made by the user to this equipment, or equipment malfunctions, may give the telecommunications company cause to request the user to disconnect the equipment.

Users should ensure for their own protection that the electrical ground connections of the power utility, telephone lines and internal metallic water pipe system, if present, are connected together. This precaution may be particularly important in rural areas.

**CAUTION:** Users should not attempt to make such connections themselves, but should contact the appropriate electric inspection authority, or electrician, as appropriate.

## Commercial Regulatory Listings

**IMPORTANT:** When used with the Alarm.com service, this security system has been evaluated and complies with *UL 1610: Central-Station Burglar-Alarm Units*. It has not been evaluated for *UL 864: Control Units and Accessories for Fire Alarm Systems* and *UL 1076: Proprietary Burglar Alarm Units and Systems*. For commercial installations (UL 1610), only one method of communication is to be used, this method of communication is a LTE (Cellular) Radio Module. See [“LTE \(Cellular\) Radio Module” on page 15](#).

**IMPORTANT:** If this installation is a commercial installation, please inform the customer (or end user) that commercial Control Panels are for use only as burglar alarm systems and not for fire protection.

**NOTE:** The standard backup battery that is included with all 2GIG Control Panels does not support UL 985 installations. To comply with the secondary supply requirement in *UL 985 Household Fire Warning System Units*, you must install the 2GIG Console Battery Pack (2GIG-BATT2X).

**IMPORTANT:** All conductors and attachments are manufactured in accordance with the Standard for *UL 681: Installation and Classification of Burglar and Holdup Alarm Systems*. The Control Panel contains hard wiring that is protected and not exposed. All conductors and attachments are manufactured in accordance with the *UL 681: Installation and Classification of Burglar and Holdup Alarm Systems*.

Stranded conductors clamped under wire-binding screws or similar parts shall have the individual strands soldered together or arranged in a construction that has been determined to be the equivalent.

**IMPORTANT:** A local alarm sounding device, alarm housing, and control unit shall comply with the mercantile requirements in UL 365: Police Station Connected Burglar Alarm Units and Systems.

## Limited Warranty

This Nortek Security & Control LLC product is warranted against defects in material and workmanship for one (1) year. This warranty extends only to wholesale customers who buy direct from Nortek Security & Control LLC or through Nortek Security & Control LLC's normal distribution channels. Nortek Security & Control LLC does not warrant this product to consumers. Consumers should inquire from their selling dealer as to the nature of the dealer's warranty, if any.

There are no obligations or liabilities on the part of Nortek Security & Control LLC for consequential damages arising out of or in connection with use or performance of this product or other indirect damages with respect to loss of property, revenue, or profit, or cost of removal, installation, or reinstallation. All implied warranties for functionality, are valid only until the warranty expires. This Nortek Security & Control LLC Warranty is in lieu of all other warranties expressed or implied.

All products returned for warranty service require a Return Authorization Number (RA#). Contact Returns at 1-855-546-3351 for an RA# and other important details.

### 2GIG

Nortek Security & Control LLC  
5919 Sea Otter Place, Suite 100, Carlsbad, CA 92010 USA

#### For technical support in the USA and Canada:

855-2GI G-TECH (855-244-4832)

Email: [2gigtechsupport@nortek.com](mailto:2gigtechsupport@nortek.com)

Visit [www.nortekcontrol.com](http://www.nortekcontrol.com) or [dealer.2gig.com](http://dealer.2gig.com) for technical support hours of operation

#### For technical support outside of the USA and Canada:

Contact your regional distributor

Visit [2gig.com/dealers/](http://2gig.com/dealers/) for a list of distributors in your region

10022312 A

